



753-697

# TWIN COMANCHE B

PA-30

## Owner's Handbook



Piper Aircraft Corporation, Lock Haven, Pa.  
U. S. A.

## NOTICE

THIS HANDBOOK IS NOT DESIGNED, NOR CAN ANY HANDBOOK SERVE, AS A SUBSTITUTE FOR ADEQUATE AND COMPETENT FLIGHT INSTRUCTION, OR KNOWLEDGE OF THE CURRENT AIRWORTHINESS DIRECTIVES, THE APPLICABLE FEDERAL AIR REGULATIONS, AND ADVISORY CIRCULARS. IT IS NOT INTENDED TO BE A GUIDE OF BASIC FLIGHT INSTRUCTION, NOR A TRAINING MANUAL.

THE HANDBOOK IS DESIGNED:

1. TO HELP YOU OPERATE YOUR TWIN COMANCHE WITH SAFETY AND CONFIDENCE.
2. TO MORE FULLY ACQUAINT YOU WITH THE BASIC PERFORMANCE AND HANDLING CHARACTERISTICS OF THE AIRPLANE.
3. TO MORE FULLY EXPLAIN YOUR TWIN COMANCHE'S OPERATION THAN IS PERMISSIBLE TO SET FORTH IN THE AIRPLANE FLIGHT MANUAL.

IF THERE IS ANY INCONSISTENCY BETWEEN THIS HANDBOOK AND THE AIRPLANE FLIGHT MANUAL APPROVED BY THE F.A.A., THE AIRPLANE FLIGHT MANUAL SHALL GOVERN.

---

Revised text and illustrations shall be indicated by a black vertical line in the margin opposite the change.

Additional copies of this manual, Part No. 753 697, may be obtained from your Piper Dealer.

---

Published by  
PUBLICATIONS DEPARTMENT  
Piper Aircraft Corporation  
753 697

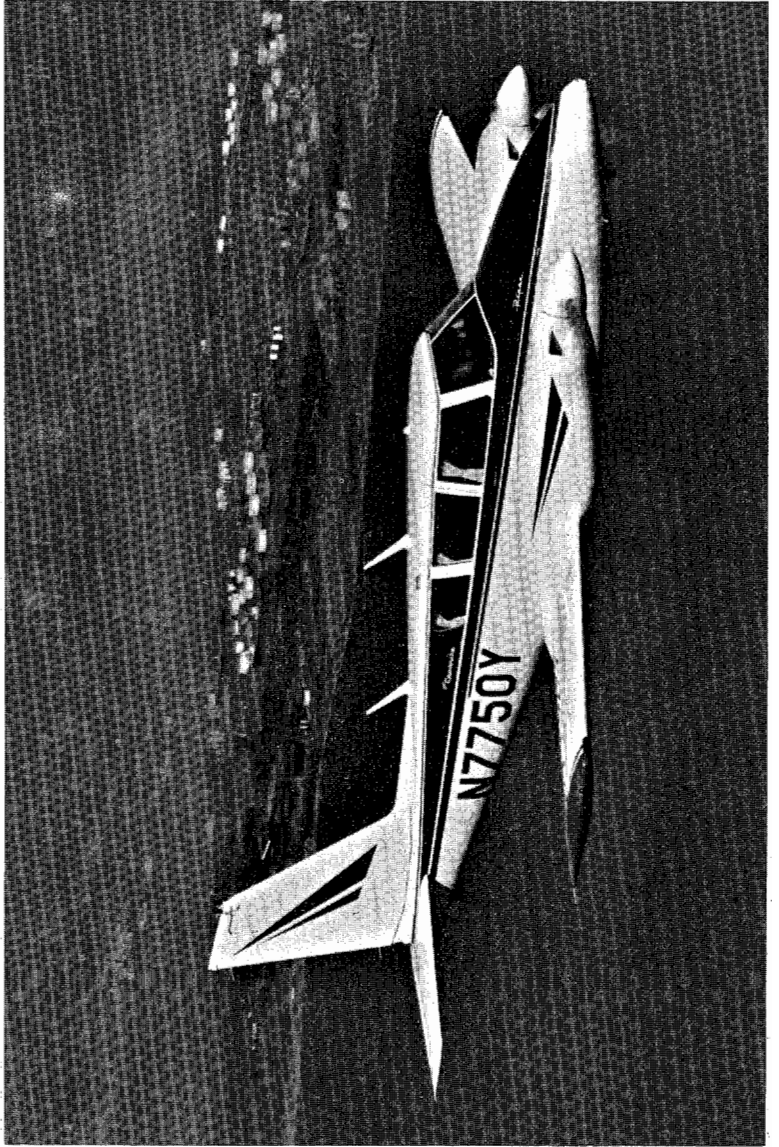



**SECTION I**  
**SPECIFICATIONS**

|                               |          |
|-------------------------------|----------|
| <b>Performance . . . . .</b>  | <b>1</b> |
| <b>Weights . . . . .</b>      | <b>2</b> |
| <b>Power Plant . . . . .</b>  | <b>3</b> |
| <b>Fuel and Oil . . . . .</b> | <b>3</b> |
| <b>Baggage Area . . . . .</b> | <b>3</b> |
| <b>Dimensions . . . . .</b>   | <b>4</b> |
| <b>Landing Gear . . . . .</b> | <b>4</b> |

## INDEX (cont)

| <b>SECTION IV (cont)</b>                             | <b>Page</b> |
|--|-------------|
| Single-Engine Climb Rate and Airspeed . . . . .      | 60          |
| Altitude Conversion Chart . . . . .                  | 61          |
| Range vs Density Altitude . . . . .                  | 62          |
| True Airspeed vs Density Altitude . . . . .          | 63          |
| Landing Distance vs Density Altitude . . . . .       | 64          |
| Landing Distance Over 50-Foot Obstacle (Short Field) | 65          |
| Power Setting Table . . . . .                        | 66          |
| Fuel Flow Chart . . . . .                            | 67          |
| <br><b>SECTION V</b>                                 |             |
| General Maintenance: . . . . .                       | 69          |
| Tire Inflation . . . . .                             | 69          |
| Battery Service . . . . .                            | 69          |
| Brake Service . . . . .                              | 70          |
| Landing Gear Service . . . . .                       | 71          |
| Fuel and Oil Requirements . . . . .                  | 71          |
| Care of Air Filter . . . . .                         | 72          |
| Care of Windshield and Windows . . . . .             | 72          |
| Serial Number Plate . . . . .                        | 75          |
| Proper Service . . . . .                             | 75          |
| Fuel System . . . . .                                | 76          |



| SECTION III (cont)                        | Page |
|---|------|
| Flooded Start . . . . .                   | 27   |
| Warm-Up and Ground Check . . . . .        | 28   |
| Electrical Power . . . . .                | 29   |
| Taxiing and Pre-Take-Off . . . . .        | 29   |
| Take-Off and Climb . . . . .              | 31   |
| Wing Flaps . . . . .                      | 31   |
| Short and Soft Field Take-Offs . . . . .  | 32   |
| Landing Gear Retraction . . . . .         | 33   |
| Deicer Boots . . . . .                    | 33   |
| V <sub>mc</sub> . . . . .                 | 33   |
| Stalls . . . . .                          | 34   |
| Spins . . . . .                           | 35   |
| Spin Recovery Technique . . . . .         | 36   |
| Cruising . . . . .                        | 36   |
| Fuel Management . . . . .                 | 37   |
| Approach and Landing . . . . .            | 39   |
| Post Landing . . . . .                    | 42   |
| Emergency Procedures . . . . .            | 42   |
| V <sub>mc</sub> Demonstration . . . . .   | 49   |
| V <sub>mc</sub> and Stall Speed . . . . . | 50   |
| Mooring . . . . .                         | 50   |
| Loading and Weight and Balance . . . . .  | 50   |
| Operating Tips . . . . .                  | 52   |
| Flight Conditions . . . . .               | 53   |
| Diving Spiral . . . . .                   | 54   |
| Radio Operation . . . . .                 | 55   |

| SECTION IV  |    |
|---|----|
| Performance Charts: . . . . .                     | 56 |
| Take-Off Ground Run Distance . . . . .            | 56 |
| Take-Off Distance Over 50-Foot Obstacle . . . . . | 57 |
| Multi-Engine Climb Rate and Airspeed . . . . .    | 59 |

**SECTION I**  
**SPECIFICATIONS**

**PERFORMANCE**

Performance figures are for airplanes equipped for cross-country transportation and flown at gross weight under standard conditions at sea level or stated altitude. Any changes in equipment may result in changes in performance.

|  |        |
|--|--------|
| Take-off Run (short field, ft)                       | 1250   |
| Take-off Distance Over 50-ft Barrier (ft)            | 2160   |
| V <sub>mc</sub> (mph) (as determined by the F.A.A.)  | 90     |
| Stalling Speed (gear and flaps down, power off, mph) | 69     |
| Stalling Speed (gear and flaps up, power off, mph)   | 76     |
| Best Rate of Climb (ft per min)                      | 1460   |
| Best Rate of Climb Speed (mph)                       | 112    |
| Best Angle of Climb Speed (mph)                      | 90     |
| Single Engine Rate of Climb (ft per min)             | 260    |
| Best Single Engine Rate of Climb Speed (mph)         | 105    |
| Absolute Ceiling (ft)                                | 20,000 |
| Service Ceiling (ft)                                 | 18,600 |
| Single Engine Absolute Ceiling (ft)                  | 7,100  |
| Single Engine Service Ceiling (ft)                   | 5,800  |
| Altitude Cruising Speeds (mph)                       |        |
| Top Speed (mph)                                      | 205    |
| Cruising Speed (75% power at sea level) (mph)        | 181    |
| Cruising Speed (75% power at 8,000) (mph)            | 194    |
| Optimum Cruising Speed (65% power at 12,000) (mph)   | 186    |

**SECTION I****TWIN COMANCHE "B"****SPECIFICATIONS (cont):****PERFORMANCE**

|  |       |
|--|-------|
| Fuel Consumption (75% power) (gph)<br>(both engines) | 17.2  |
| Fuel Consumption (65% power) (gph)<br>(both engines) | 15.2  |
| Cruising Range (75% power at 8,000 ft) (mi)          | 948*  |
| Cruising Range (65% power at 12,000 ft) (mi)         | 1025* |
| Cruising Range (45% power at 16,000 ft) (mi)         | 1116* |
| * 84 gal. usable fuel                                |       |
| Landing Roll (short field, flaps down, ft)           | 700   |
| Landing Over 50-ft Barrier (flaps down, ft)          | 2100  |

**WEIGHTS**

|                               |       |
|-------------------------------|-------|
| Gross Weight (lbs)            | 3600  |
| Empty Weight (Standard) (lbs) | 2207* |
| USEFUL LOAD (Standard) (lbs)  | 1393* |

\*These weights are approximate.

**INDEX**

| <b>SECTION I</b>                            | <b>Page</b> |
|---|-------------|
| Specifications: . . . . .                   | 1           |
| Performance . . . . .                       | 1           |
| Weights . . . . .                           | 2           |
| Power Plant . . . . .                       | 3           |
| Fuel and Oil . . . . .                      | 3           |
| Baggage Area . . . . .                      | 3           |
| Dimensions . . . . .                        | 4           |
| Landing Gear . . . . .                      | 4           |
| <b>SECTION II</b>                           |             |
| Design Information: . . . . .               | 6           |
| Engine and Propeller . . . . .              | 6           |
| Fuel Injection . . . . .                    | 7           |
| Structures . . . . .                        | 8           |
| Landing Gear . . . . .                      | 8           |
| Control System . . . . .                    | 10          |
| Fuel System . . . . .                       | 11          |
| Electrical System . . . . .                 | 14          |
| Vacuum System . . . . .                     | 16          |
| Instrument Panel . . . . .                  | 17          |
| Instrument Static Pressure System . . . . . | 20          |
| Heating and Ventilating System . . . . .    | 21          |
| Seats . . . . .                             | 22          |
| Finish . . . . .                            | 23          |
| Baggage Area . . . . .                      | 23          |
| Stall Warning System . . . . .              | 24          |
| <b>SECTION III</b>                          |             |
| Operating Instructions: . . . . .           | 25          |
| Preflight . . . . .                         | 25          |
| Starting Engines. . . . .                   | 27          |

**SPECIFICATIONS (cont):****POWER PLANT**

|                          |          |
|--------------------------|----------|
| Engine - Lycoming        | IO-320-B |
| Rated Horsepower         | 160      |
| Rated Speed (rpm)        | 2700     |
| Bore (in.)               | 5.125    |
| Stroke (in.)             | 3.875    |
| Displacement (cubic in.) | 319.8    |
| Compression Ratio        | 8.5:1    |
| Dry Weight (lbs)         | 295      |

**FUEL AND OIL**

|                                       |       |
|---------------------------------------|-------|
| Fuel Capacity (U.S. gal)              | 90    |
| Unusable fuel (inboard tanks only)    | 6     |
| Fuel, Aviation Grade (minimum octane) | 91/96 |
| Oil Capacity (qts) (each engine)      | 8     |

**BAGGAGE AREA**

|                          |         |
|--------------------------|---------|
| Maximum Baggage (lbs)    | 250     |
| Baggage Space (cubic ft) | 20      |
| Baggage Door Size (in.)  | 19 x 21 |

## SPECIFICATIONS (cont):

## DIMENSIONS

|                              |      |
|------------------------------|------|
| Wing Span (ft)               | 36   |
| Wing Area (sq ft)            | 178  |
| Length (ft)                  | 25.2 |
| Height (ft)                  | 8.2  |
| Wing Loading (lbs per sq ft) | 20.2 |
| Power Loading (lbs per hp)   | 11.3 |
| Propeller Diameter (in.)     | 72   |

## LANDING GEAR

|                     |                                |
|---------------------|--------------------------------|
| Wheel Base (ft)     | 7.3                            |
| Wheel Tread (ft)    | 9.8                            |
| Tire Pressure (psi) | Nose 42                        |
|                     | Main 42                        |
| Tire Size           | Nose (six-ply rating) 6.00 x 6 |
|                     | Main (six-ply rating) 6.00 x 6 |

## NOTES

| CHAMBER PRESSURE REQUIREMENTS<br>WITH TEMPERATURE |              |          |              |
|---|--------------|----------|--------------|
| Temp. °F  | Press. (psi) | Temp. °F | Press. (psi) |
| 100   | 188          | 30       | 165          |
| 90  | 185          | 20       | 162          |
| 80  | 182          | 10       | 159          |
| 70  | 178          | 0        | 154          |
| 60  | 175          | -10      | 152          |
| 50  | 172          | -20      | 149          |
| 40  | 168          | -30      | 146          |

NOTE: Do not check pressure or charge with propeller in feather position.

## FUEL SYSTEM

The fuel screens in the strainers require cleaning at fifty hour or ninety day intervals whichever first occurs. The fuel strainers beneath the floor panel are accessible through a plate in the underside center of the fuselage. The fuel injector screen is located in the housing where the fuel inlet line connects the injector. This screen should be cleaned every fifty hours of operation.

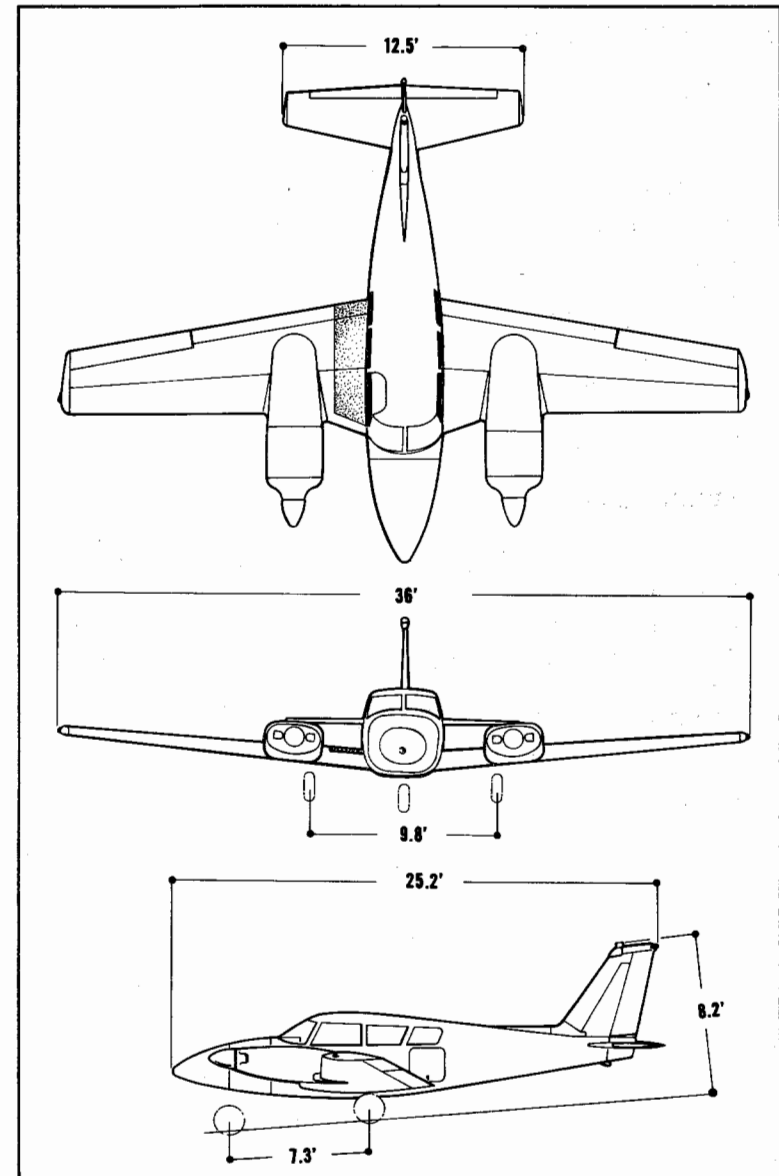

3. Remove oil, grease or sealing compounds with a cloth soaked in kerosene.
4. After cleaning, apply a thin coat of hard polishing wax. Rub lightly with a soft dry cloth.
5. A severe scratch or mar can be removed by using jeweler's rouge. After the flaw has been removed apply wax to the area.

### SERIAL NUMBER PLATE

The serial number plate may be found at the following locations: On the forward upper portion of the forward cabin bulkhead; inside the fuselage on the left skin opposite the rear fuselage access panel; or on the fuselage adjacent to the left side of the tail skid. Airplane serial numbers should be used when contacting the factory on service or warranty matters.

### PROPELLER SERVICE

The air charge in the propeller cylinder should be kept at the pressure specified on the placard located in the spinner cap. (A copy of the placard is shown on page 76.) The pressure in the cylinder will increase about one-third psi for every Fahrenheit degree increase in temperature. This effect should be considered when checking pressure. The charge maintained must be accurate and free of excessive moisture since moisture may freeze the piston during cold weather. Dry nitrogen gas is recommended.

much as 100% on engines equipped with full flow cartridge type oil filters provided the element is replaced each 50 hours of operation. The following grades are required for the specified temperatures:

|                                      |           |
|--------------------------------------|-----------|
| Temperatures above 60° F             | S.A.E. 50 |
| Temperatures between 30° F and 90° F | S.A.E. 40 |
| Temperatures between 0° F and 70° F  | S.A.E. 30 |
| Temperatures below 10° F             | S.A.E. 20 |

### CARE OF FILTER

The induction air filters must be cleaned at least once every fifty hours. Depending on the type of condition existing, it may be necessary to clean the filters more often.

The following cleaning procedure is recommended by the manufacturer of the filter:

1. Remove the filter from the engine compartment.
2. Tap filter gently to remove dirt particles. Do not use compressed air or cleaning solvents.
3. Reinstall air filter.

### CARE OF WINDSHIELD AND WINDOWS

The following procedure is recommended for care of the plexiglas windows:

1. Flush with clean water and dislodge excess dirt and mud by hand.
2. Wash with mild soap and warm water, using a soft cloth or sponge. Do not rub.

## SECTION II

### DESIGN INFORMATION

#### ENGINE AND PROPELLER

The Lycoming IO-320-B four cylinder, fuel injected engines are rated at 160 horsepower at 2700 rpm. These engines are equipped with geared starters, fuel injectors and shielded ignition systems.

Engine mounts are of steel tube dynafocal mount construction. Engine cowls are cantilever structures attached at the firewall, with side panels which are quickly removed by means of quick release fasteners.

The exhaust system is a cross-over type with exhaust gases directed overboard at the bottom of the nacelles in the area of the cowl flaps. The cowl flaps are located on the bottom of the engine nacelles and are manually operated by push-pull controls located in the cabin to the right of the power control quadrant.

Oil coolers are mounted on the left rear baffle of each engine. Air passes through the oil coolers before reaching the area of the cowl flaps.

The propellers are Hartzell HC-E2YL-2 constant-speed, controllable, full-feathering units. These are controlled entirely by use of the propeller control levers located in the center of the power control quadrant. Feathering of the propellers is accomplished by moving the controls fully aft through the low RPM detent into the feathering position. Feathering takes place in approximately three seconds. A propeller is unfeathered by moving the prop control ahead and engaging the starter. (See Section III for complete feathering and unfeathering instructions.)

**FUEL INJECTION**

The Bendix RSA-5 fuel injection system is based on the principle of measuring engine air consumption by use of a venturi tube and using airflow to control fuel flow to the engines. Fuel distribution to the cylinders is accomplished by a fuel flow divider.

Fuel pressure regulation by means of the servo valve causes a minimal drop in fuel pressure throughout the metering system. Metering pressure is maintained above vapor forming conditions while fuel inlet pressure is low enough to allow the use of a diaphragm pump. Vapor lock and associated problems of difficult starting are thus eliminated.

Incorporated in the servo regulator is the airflow sensing system which contains a throttle valve and venturi. The differential pressure between the entrance and the throat of the venturi is the measurement of air entering the engine. These pressures are applied across an air diaphragm in the regulator. A change in power changes the airflow to the engine and across the diaphragm in the regulator.

Mounted on top of the engine is the ported fuel flow divider with four nozzle lines routed to the cylinders. The divider contains a spring loaded positive shut-off valve. Within each cylinder are continuous flow air bleed nozzles with provisions to eliminate the adverse effects of low manifold pressure when idling. Since fuel metering is provided by the servo regulator rather than the nozzles, more uniform cylinder head temperatures result and a longer engine life is possible.

Induction air for the engine enters the opening in the nose cowl and is picked up by a large air duct at the right rear baffle. The air is directed through a filter and on to the servo regulator. An alternate air source for the induction system contains a spring loaded door at the throat of the servo regulator. This door operates automatically if primary source is obstructed or manually by the push-pull control on the right side of the power control quadrant. The primary system should always be used for take-off.

removed, it is possible to remove the main wheels by taking off the dust cover and axle nut.

**LANDING GEAR SERVICE**

To raise the aircraft for servicing, use two hydraulic jacks and a tail support. Place about 300 pounds of ballast on the base of the tail support before jacking the aircraft.

Landing gear oleos should be serviced according to instruction on the units. All three oleos should be extended until about two and three-quarter inches of oleo strut extension is exposed in static position.

To add air to the oleo struts, attach a strut pump to the air valve and pump the oleo up to the proper position. To add oil, release the air through the strut valve, and allow the strut to extend fully. Remove the air valve and fill the unit through its opening. Compress the oleo to within one-quarter inch of full compression, allowing air and excess oil to escape. Reinsert the valve core and pump up the strut.

**FUEL AND OIL REQUIREMENTS**

A minimum octane of 91/96 Aviation Grade fuel must be used in the Twin Comanche. Since the use of lower grades of fuel can cause serious engine damage in a short period of time, the engine warranty is invalidated by use of lower octanes.

The oil capacity of the Lycoming IO-320-B is 8 quarts with a minimum safe quantity of 2 quarts. It is recommended that engine oil be changed every 50 hours or sooner under unfavorable conditions. Intervals between oil changes can be increased as



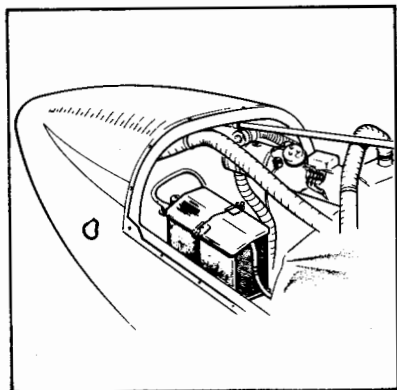

#### Battery Installation

section. Be sure that master switch is off while inserting or removing a plug at this receptacle.

plates. It should be checked frequently to determine that the fluid level is proper and the connections are tight and free of corrosion.

If the battery is not properly charged, recharge it starting with a rate of 4 amperes and finishing with a rate of 2 amperes. Quick charges are not recommended.

The external power receptacle, if installed, is located

on the left side of the nose

#### BRAKE SERVICE

The brake system is filled with MIL-H-5606 (petroleum base) hydraulic brake fluid. This should be checked at every 100 hour inspection and replenished when necessary. Refill the brake reservoir on the aft bulkhead of the nose section to the indicated level.

No adjustment of brake clearance is necessary. If the brake blocks become worn to 1/64 inch minimum lining, replace them with new brake segments. Remove the four cap bolts that join the brake cylinder housing and lining back plate assemblies, then remove the back plates from between the brake disc and wheel. Slide the brake cylinder housing from the torque plate and slide the pressure plate and lining from the anchor bolts of the cylinder housing. Remove the lining by prying it from the pressure plate and back plates. With the four cap bolts

#### STRUCTURES

Structures are of sheet aluminum construction and are designed to ultimate load factors well in excess of normal requirements. All components are completely zinc chromate primed and exterior surfaces are coated with acrylic lacquer.

The main spars of the wings are joined with high strength butt fittings in the center of the fuselage, making in effect a continuous main spar. The spars are attached to the fuselage at the side of the fuselage and in the center of the structure; wings are also attached at the rear spar and at an auxiliary front spar.

The wing airfoil section is a laminar flow type, NACA-642A215, with maximum thickness about 40% aft of the leading edge. This permits the main spar, located at the point of maximum thickness, to pass through the cabin under the rear seat, providing unobstructed cabin floor space ahead of the seat.

#### LANDING GEAR

The nose gear is steerable with the rudder pedals through a 40 degree arc. During retraction of the gear, the steering mechanism is disconnected automatically to reduce rudder pedal loads in flight. The nose gear is equipped with a hydraulic shimmy dampener.

Retraction of the landing gear is accomplished through the use of an electric motor and gear train, actuating push-pull cables to each of the main gear and a tube to the nose gear. The landing gear motor is beneath the center floor panel and the selector switch on the instrument panel to the left of the power control quadrant.

To guard against inadvertent movement of the landing gear selector on the ground, the handle must also be pulled aft before moving it upward. The gear selector has the shape of a wheel to

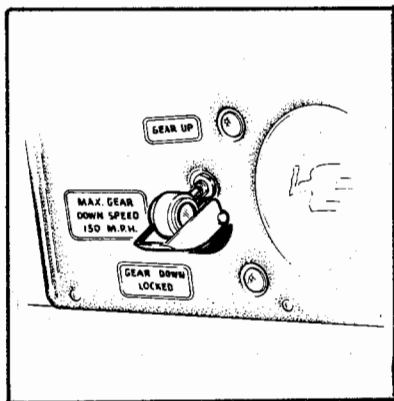

### Gear Selector Switch

This prevents the completion of the electric circuit to the landing gear motor until the gear strut is within  $3/4$  inch of full extension.

The gear indicating lights are located conveniently above and below the gear selector switch. The green indicating light (located below the selector switch) shows that all gears are down and locked. The amber light (located above the gear selector switch) is the gear up indication. The amber light will flash when power is reduced on one engine and the gear is up. The warning horn will operate when power is reduced (below approximately 12" of manifold pressure) on both engines and the gear is not down and locked. The pilot should become familiar with the gear warning horn to distinguish it from the stall warning horn. GEAR INDICATION LIGHTS ARE AUTOMATICALLY DIMMED WHEN THE INSTRUMENT LIGHTS ARE TURNED ON.

The brakes are actuated by toe brake pedals mounted on the left set of the rudder pedals. Hydraulic brake cylinders above the brake pedals are accessible in the cockpit for servicing. Parking brake valves are incorporated in each cylinder and have two cables attached from the parking brake "T" handle. To prevent inadvertent application of the parking brake in flight, a safety lock is incorporated in the valves, thus eliminating the possibility of pulling out the "T" handle until pressure is applied by use of the toe brakes. Toe brakes for the right side are available as optional equipment.

distinguish it from the electric flap control which has an air-foil shape. As an added safety feature, the warning horn is connected to the gear selector switch. The horn will then operate if the selector is moved to the UP position with the master switch on and the weight of the airplane on the landing gear. To prevent gear retraction on the ground, an anti-retraction switch is installed on the left main gear.

## SECTION V

### GENERAL MAINTENANCE

This section contains information on preventive maintenance. Refer to the Twin Comanche Service Manual for further maintenance. Any complex repair or modification should be accomplished by a Piper Certified Service Center.

### TIRE INFLATION

For maximum service from the tires, keep them inflated to the proper pressure of 42 psi. Interchange the tires periodically for even wear. All wheels and tires are balanced before original installation, and the relationship of tire, tube and wheel should be maintained upon reinstallation. In the installation of new components, it may be necessary to rebalance the wheels with the tires mounted. Out of balance wheels can cause extreme vibration in the landing gear.

### BATTERY SERVICE

Access to the 12-volt 35 ampere hour battery is gained through the top panel of the fuselage nose section. The stainless steel battery container has a plastic drain tube which is normally closed off with a clamp that should be opened occasionally to drain off any accumulation of fluid.

The battery fluid level must not be brought above the baffle

A tow bar is provided with each aircraft. When not in use it is stowed next to the main spar. It may be removed by lifting the flap covering the forward side of the spar and removing the bar from its fasteners.

When towing with power equipment, caution should be used not to turn the nose gear beyond its 40 degree arc as this may cause damage to the nose gear and steering mechanism.

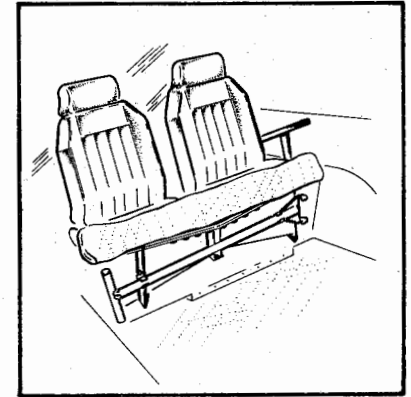

**Tow Bar Stowage**

## CONTROL SYSTEM

Dual flight controls are provided as standard equipment. Cables connect the movable control surfaces with the rudder pedals and control columns.

Directional and longitudinal trim is provided by an adjustable trim mechanism for the rudder and stabilator. The manual rudder trim control is located to the right of the throttle quadrant.

Max-Lift electrically operated flaps are used on the Twin Comanche. The flaps are operated by an electric motor; they can be lowered

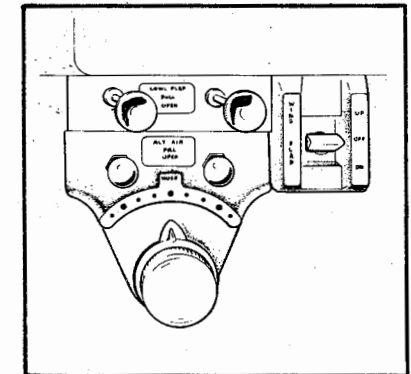

**Rudder Trim and Flap Controls**

and stopped in any desired position. The airfoil shaped flap control is to the right of the power control quadrant. Located on the instrument panel is a flap position indicator marked to show the position of the flap relative to the wing. A range for take-off operation is also shown.

Located in the inboard end of the right flap is a lock which holds the flap in the UP position so that it can be used as a step for entry or exit. A second lock is incorporated to prevent the flap from going full down in case a step load is applied and the up lock is not fully engaged.

## FUEL SYSTEM

The fuel is carried in four integral fuel cells located in the leading edge sections of the wings. Capacity of the two main fuel cells is 30 gallons each, of which 27 gallons is usable.

The auxiliary fuel system consists of two 15 gallon cells (all usable) installed in the wings just outboard of the main fuel cells. Wing tip tanks are available as optional equipment. Auxiliary fuel and tip tank fuel is to be used in level flight only.

The cells should be kept full of fuel during storage of the airplane to prevent accumulation of moisture and deterioration of the cells. For storage of more than ten days without fuel, the cells should be coated with light engine oil to prevent excessive drying.

During normal operation use the engine driven fuel pump to draw fuel from the cell directly adjacent to that engine. However, fuel can be drawn from any cell to both engines through use of the engine driven fuel pump or the electric auxiliary fuel pump.

For emergency single engine operation a crossfeed is provided to increase the range. When using fuel from tanks on the same side as the operating engine, the position of the fuel selector will remain the same as for normal operation with the

## SECTION V

### GENERAL MAINTENANCE

|  |    |
|--|----|
| Tire Inflation . . . . .                 | 69 |
| Battery Service . . . . .                | 69 |
| Brake Service . . . . .                  | 70 |
| Landing Gear Service . . . . .           | 71 |
| Fuel and Oil Requirements . . . . .      | 71 |
| Care of Air Filter . . . . .             | 72 |
| Care of Windshield and Windows . . . . . | 72 |
| Serial Number Plate . . . . .            | 75 |
| Propeller Service . . . . .              | 75 |
| Fuel System . . . . .                    | 76 |

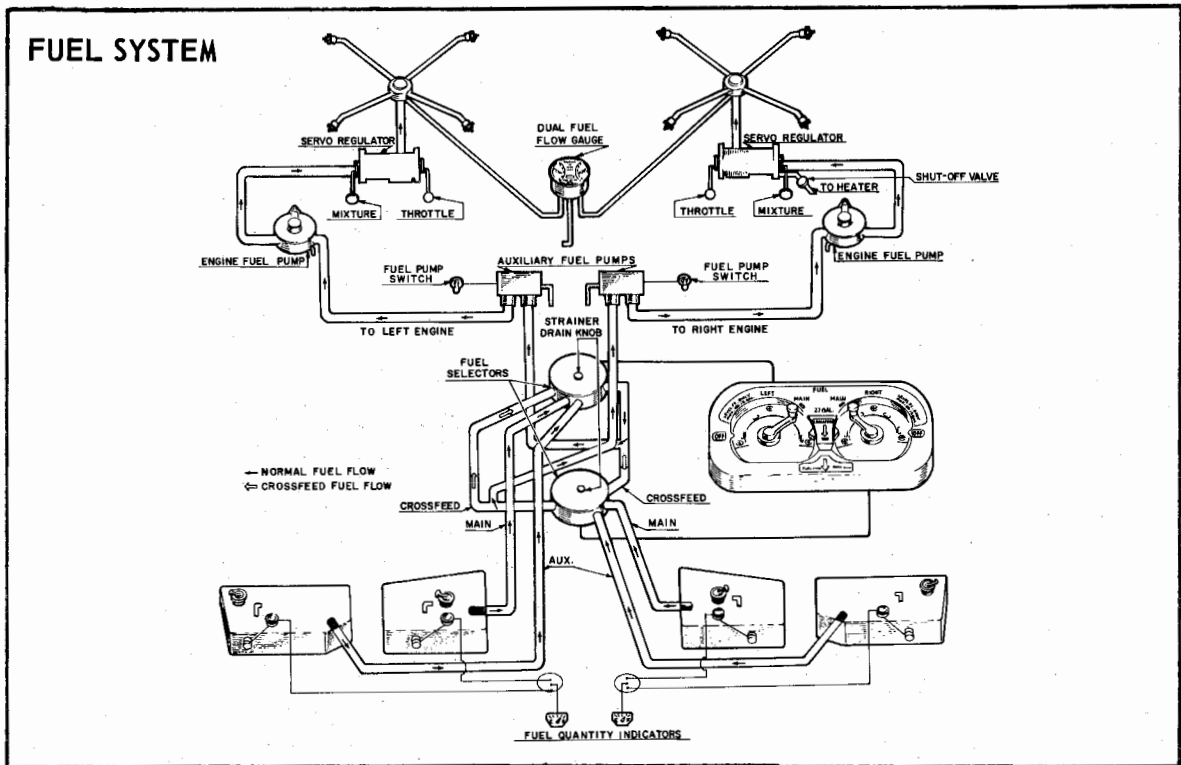

auxiliary fuel pump off unless the engine driven pump is inoperative.

**NOTE**

Do not put both fuel selectors in the crossfeed position at the same time.

When using fuel from cells on the opposite side of the operating engine, move the fuel selector for the inoperative engine to the main or auxiliary position; then move the fuel selector for the operating engine to the crossfeed position.

For single engine landing, fuel must be pumped from the main cell on the same side as the operating engine.

The fuel strainers for the system are located beneath the floor panel in the center section of the fuselage. Daily draining of the strainers may be accomplished in the cockpit by opening the hinged access door located in the floor panel just aft of the fuel selector handles and pulling up on the knob located in the center of the selector valve. The general procedure for draining the fuel system is to open the strainer quick drain for several seconds with the fuel cell selector on the main cell, then to change the selector to the auxiliary cell and repeat the process. Allow enough fuel flow to clear the lines as well as the strainer. Positive fuel flow shut-off can be observed through the clear plastic tube that carries the fuel overboard. Located inside the fuel valves is a by-pass valve which will open at 1/2 psi differential pressure if the strainer screen becomes blocked.

Fuel quantity is indicated by two electric gauges located below the instrument cluster. The instruments are connected to a transmitter unit located in each fuel cell. The gauges will indicate the amount of fuel available in the cells that are selected.

**NOTES**

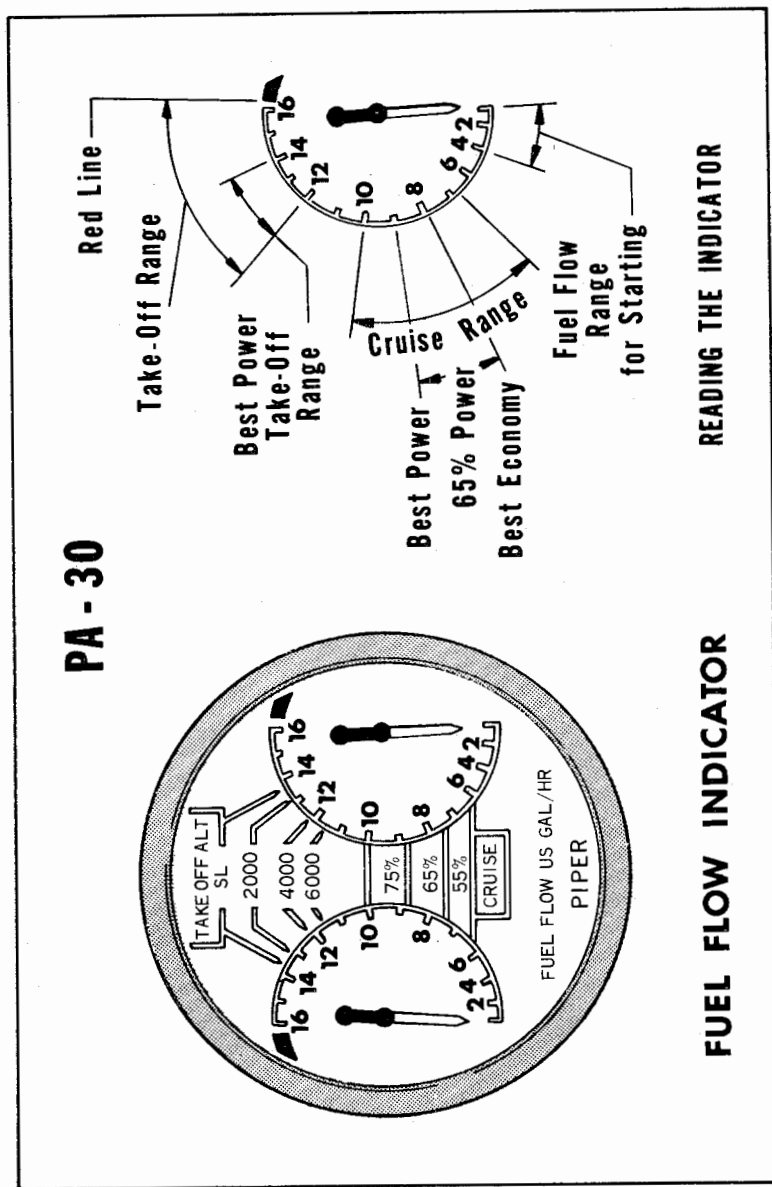
**ELECTRICAL SYSTEM**

Electrical power for the Twin Comanche is supplied by a 12 volt, direct current system. Incorporated in the system as standard equipment are a 12 volt 50 ampere generator and a 35 ampere-hour battery, which furnish electrical power during operation. The battery is located in the fuselage nose section, in a sealed stainless steel battery box. Refer to the Maintenance Section for servicing of the battery. Dual generators are available as optional equipment.

Electrical switches for the various systems are located on the lower left instrument panel. The circuit breakers, located under the floorboard aft of the nose wheel well, automatically break the electrical circuit if an overload occurs. To reset the circuit breakers simply push in the reset button. It may be necessary to allow approximately two minutes for the circuit breakers to cool before resetting them. Corrective action should be taken in event of continual circuit breaker popping. It is possible to manually trip the breaker by pulling out on the reset button.

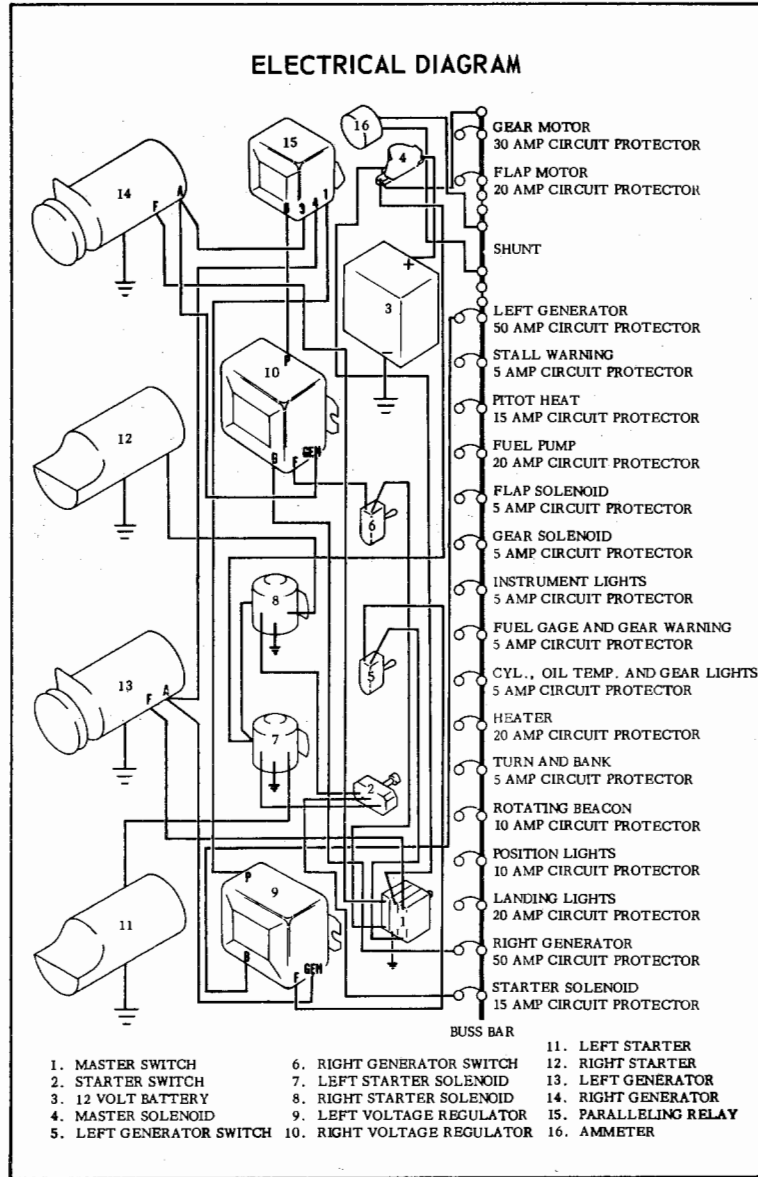
**Power Setting Table - Lycoming Model 10-320-B-160 HP Engine**

| Press | Std. Alt. 1000 Feet | 88 HP - 55% Rated RPM AND MAN. PRESS. |      |      | 104 HP - 65% Rated RPM AND MAN. PRESS. |      |      | 120 HP - 75% Rated RPM AND MAN. PRESS. |      |      |      |      |
|-------|---------------------|---------------------------------------|------|------|--|------|------|--|------|------|------|------|
|       |                     | 2100                                  | 2200 | 2300 | 2400                                   | 2100 | 2200 | 2300                                   | 2400 | 2200 | 2300 | 2400 |
| SL    | 59                  | 22.4                                  | 21.7 | 21.0 | 20.4                                   | 25.0 | 24.2 | 23.3                                   | 22.7 | 26.5 | 25.6 | 24.9 |
|       | 55                  | 22.1                                  | 21.5 | 20.7 | 20.2                                   | 24.7 | 23.9 | 23.0                                   | 22.4 | 26.2 | 25.3 | 24.6 |
|       | 52                  | 21.8                                  | 21.2 | 20.5 | 19.9                                   | 24.4 | 23.6 | 22.8                                   | 22.2 | 25.9 | 25.0 | 24.3 |
|       | 48                  | 21.6                                  | 20.9 | 20.2 | 19.7                                   | 24.1 | 23.3 | 22.5                                   | 21.9 | 25.6 | 24.7 | 24.0 |
|       | 45                  | 21.3                                  | 20.6 | 19.9 | 19.4                                   | 23.8 | 23.0 | 22.2                                   | 21.6 | 25.3 | 24.3 | 23.7 |
|       | 41                  | 21.0                                  | 20.4 | 19.7 | 19.2                                   | 23.5 | 22.7 | 21.9                                   | 21.3 | FT   | 24.0 | 23.4 |
|       | 38                  | 20.8                                  | 20.1 | 19.4 | 18.9                                   | 23.2 | 22.4 | 21.6                                   | 21.1 | ---  | FT   | 23.1 |
|       | 34                  | 20.5                                  | 19.8 | 19.1 | 18.7                                   | FT   | 22.1 | 21.3                                   | 20.8 | ---  | ---  | ---  |
|       | 31                  | 20.2                                  | 19.5 | 18.9 | 18.4                                   | ---  | 21.8 | 21.0                                   | 20.5 | ---  | ---  | ---  |
|       | 27                  | 19.9                                  | 19.2 | 18.6 | 18.2                                   | ---  | FT   | 20.7                                   | 20.3 | ---  | ---  | ---  |
|       | 23                  | 19.7                                  | 19.0 | 18.3 | 17.9                                   | ---  | ---  | FT                                     | 20.0 | ---  | ---  | ---  |
|       | 19                  | 19.4                                  | 18.7 | 18.1 | 17.7                                   | ---  | ---  | ---                                    | ---  | ---  | ---  | ---  |
|       | 16                  | FT                                    | 18.4 | 17.8 | 17.4                                   | ---  | ---  | ---                                    | ---  | ---  | ---  | ---  |
|       | 13                  | ---                                   | ---  | ---  | 17.2                                   | ---  | ---  | ---                                    | ---  | ---  | ---  | ---  |
|       | 12                  | ---                                   | ---  | ---  | 17.5                                   | ---  | ---  | ---                                    | ---  | ---  | ---  | ---  |
|       | 9                   | ---                                   | ---  | ---  | 16.9                                   | ---  | ---  | ---                                    | ---  | ---  | ---  | ---  |
|       | 5                   | ---                                   | ---  | ---  | ---                                    | ---  | ---  | ---                                    | ---  | ---  | ---  | ---  |

To maintain constant power, correct manifold pressure approximately 0.17" Hg. for each 10° F variation in induction air temperature from standard altitude temperature. Add manifold pressure for air temperatures above standard; subtract for temperatures below standard.



# TWIN COMANCHE

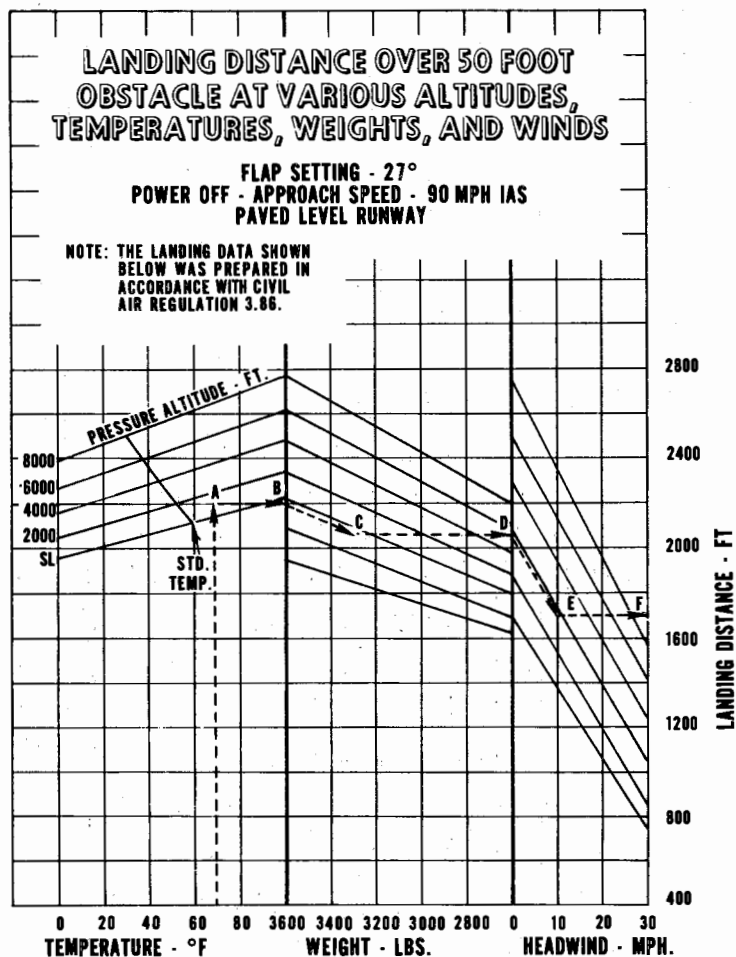

## VACUUM SYSTEM

Suction for the vacuum operated gyro instruments is supplied by two engine driven (dry type) vacuum pumps, interconnected to form a single system. Either vacuum pump has sufficient capacity to operate the gyro instruments. If suction is lost from one or the other side a check valve automatically closes and suction is supplied by the remaining system.

A vacuum gauge is installed in the instrument panel to provide a constant indication of vacuum source. Incorporated in the instrument are two red indicators (right and left systems). During normal operation the indicators are not visible, but if vacuum is lost, for example on the right side, then the right indicator will be visible. Suction is indicated on the gauge in inches of mercury; normal operating range is 4.8 to 5.1 inches. The system is controlled by two adjustable regulators, one located in each engine nacelle. After initial adjustment the regulators require very little attention.

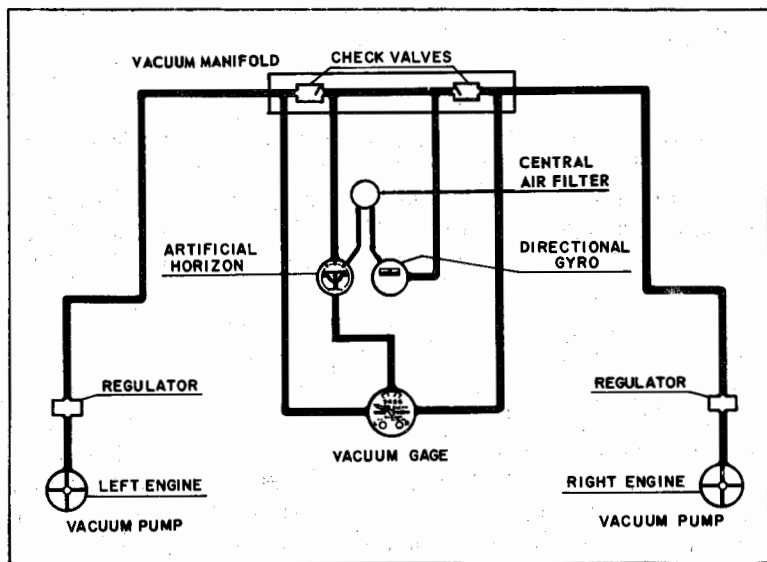

**INSTRUMENT PANEL**

The instrument panel is designed to accommodate the customary advanced flight instruments on the left side in front of the pilot and engine instruments on the right side. The optional instruments such as the gyro instruments of the flight group are shock mounted. The Artificial Horizon and Directional Gyro in this group are operated by an optional vacuum pump on each engine. The vacuum system standby is the optional, electrically operated Rate of Turn Indicator.

**TWIN COMANCHE**

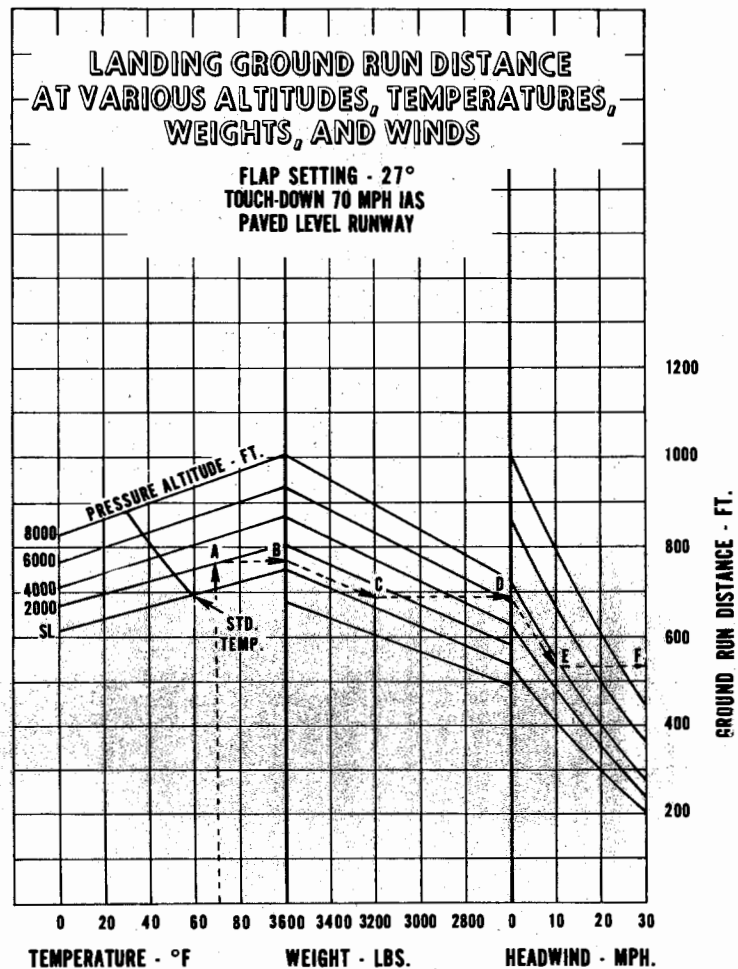

# TWIN COMANCHE

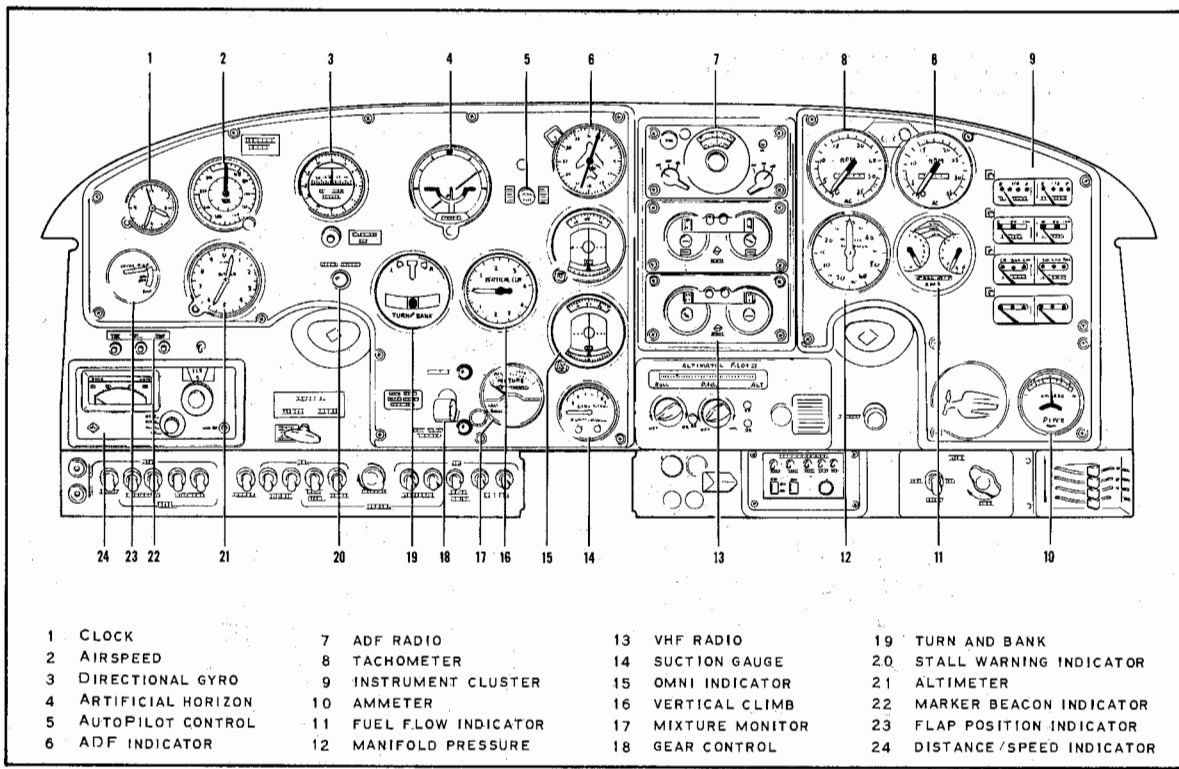
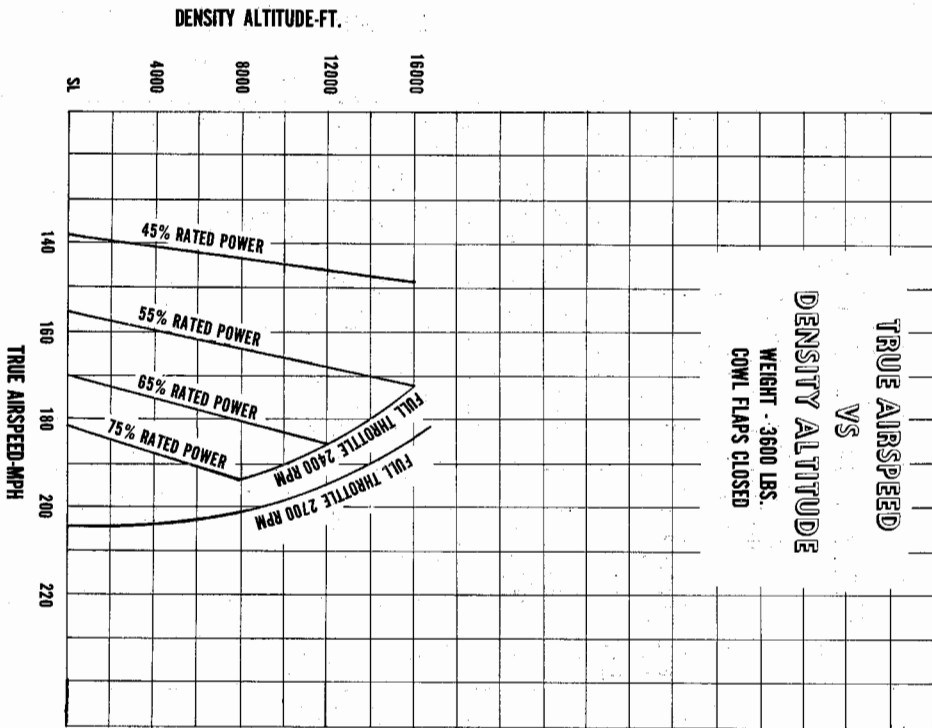

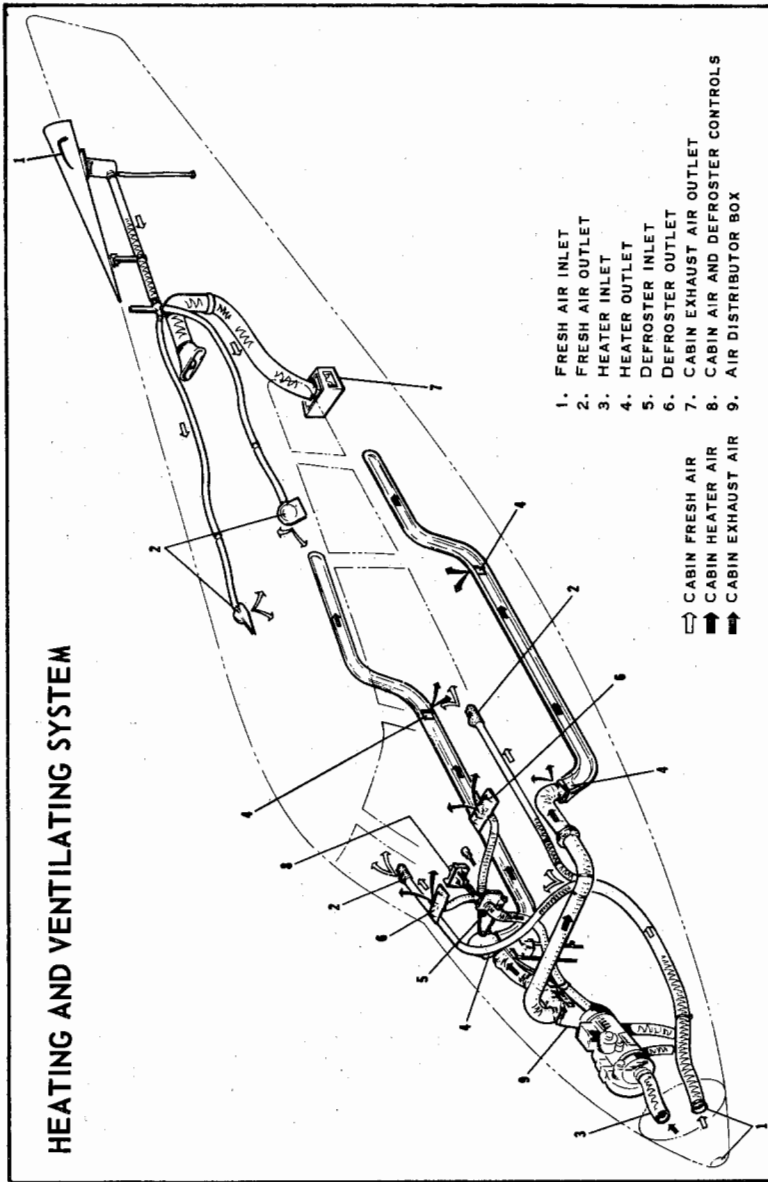

# TWIN COMANCHE

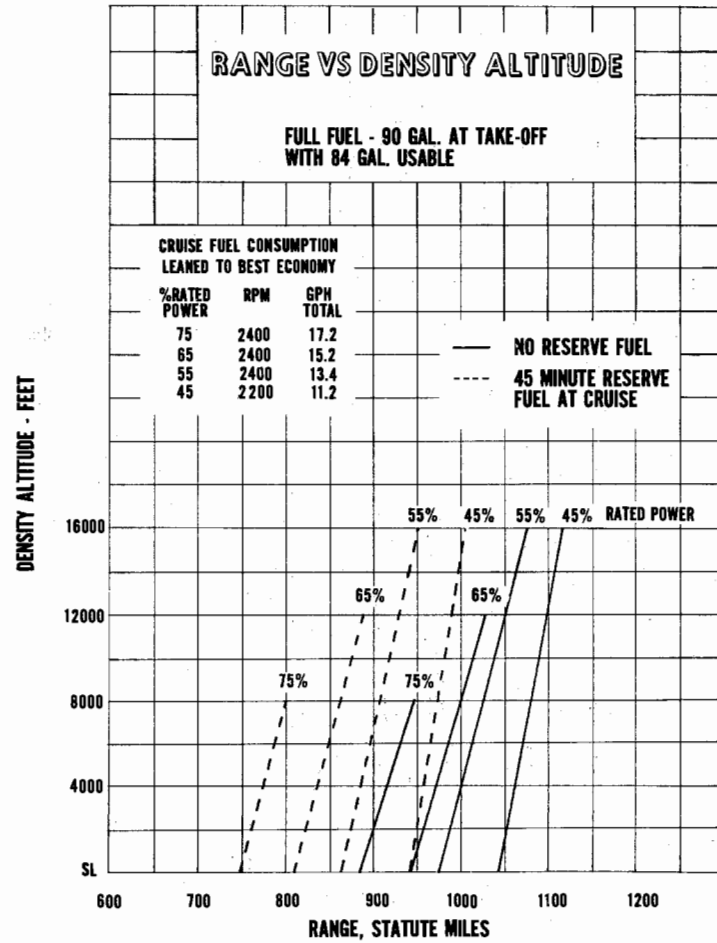

# TWIN COMANCHE

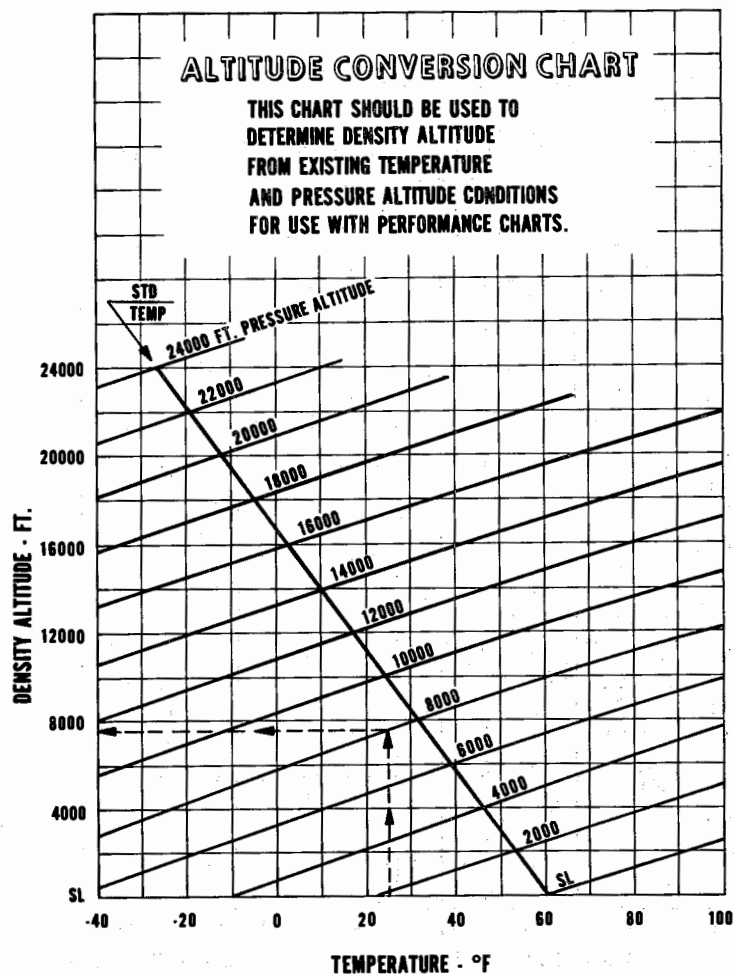

## INSTRUMENT STATIC PRESSURE SYSTEM

Static air for the airspeed indicator, altimeter and vertical speed indicator is supplied from two static ports, one located on each side of the aft fuselage section.

An optional, alternate static source is available to provide continuous operation of the pitot static instruments should the static system ports or lines become obstructed. The alternate static source is located in the cabin on the lower left side of the control quadrant.

If incorrect instrument readings are suspected the alternate static source valve should be opened, venting the static system to cabin pressure. Cabin pressure will vary, however with cabin ventilators open, cabin heater operating and various airspeeds.

Use of the alternate static source may result in the following instrument indications: The altimeter reads higher than normal; indicated airspeed greater than normal; and the vertical velocity indicator momentarily shows a climb.

The following table shows airspeed corrections for the standard static system and the alternate static system:

|            | Standard<br>Static System | Alternate<br>Static System | Gear and<br>Flaps |
|------------|---------------------------|----------------------------|-------------------|
| IAS<br>MPH | CAS<br>MPH                | CAS<br>MPH                 |                   |
| 80         | 82                        | 81                         | Retracted         |
| 88         | 90                        | 91                         |                   |
| 120        | 121                       | 113                        |                   |
| 160        | 160                       | 148                        |                   |
| 200        | 197                       | 185                        |                   |
| 220        | 216                       | 204                        |                   |
| 80         | 80                        | 81                         | Extended          |
| 91         | 90                        | 91                         |                   |
| 100        | 98                        | 97                         |                   |
| 120        | 117                       | 113                        |                   |

## HEATING AND VENTILATING SYSTEM

The flow of air for heating and defrosting is taken through an inlet located in the nose and regulated by controls located in the lower right side of the instrument panel.

Heated air for the cabin and windshield defrosting is provided by a Janitrol heater installed in the nose section.

Operation of the heater is controlled by a three position switch, labeled FAN, OFF and HEAT. The FAN position will operate the vent blower only and may be used for cabin ventilation on the ground or for windshield defogging when heat is not desired.

For heat the manual heater fuel valve must be on and the three position switch turned to HEAT. This will start fuel flow and ignite the burner simultaneously. With instant starting and no need for priming, heat should be felt within a few seconds.

Regulation of heat, airflow and defroster operation is controlled by levers on the heater control console. The top control regulates a thermostat and provides a wide range of temperature selections. Adjustable heat deflectors are on the cabin wall beneath the instrument panel to provide additional comfort.

Cabin temperature and air circulation can be maintained by using various combinations of lever settings, to suit individual desires. To minimize the feeling of drafts, a low airflow high heat combination may be used.

Windshield defrosting may be regulated by various settings of the defroster lever and in severe windshield fogging or icing conditions, it may be desirable to restrict the heater air, since this will drive more air through the defrosters.

Heat may be supplied to warm the cabin before flight by turning on the master switch, the right auxiliary fuel pump, and starting the heater.

The cabin heater uses gasoline from the fuel injector on the right engine. If the right fuel selector is in the off position the heater is inoperative. In case of right engine failure the heater can be operated by leaving the fuel selector on and closing the

## TWIN COMANCHE

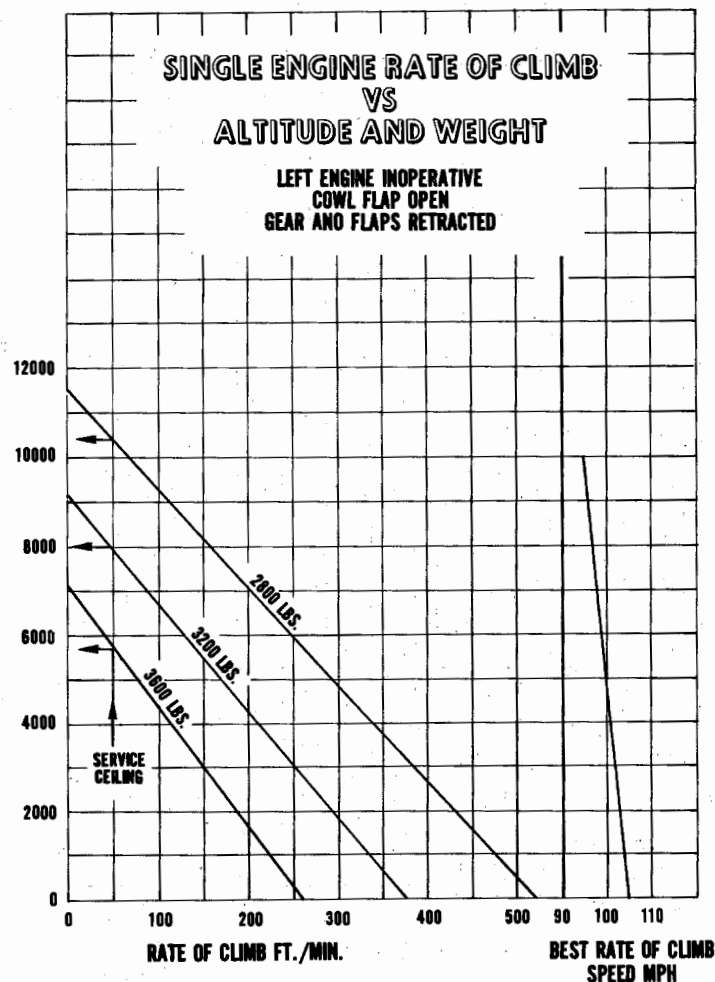

# TWIN COMANCHE

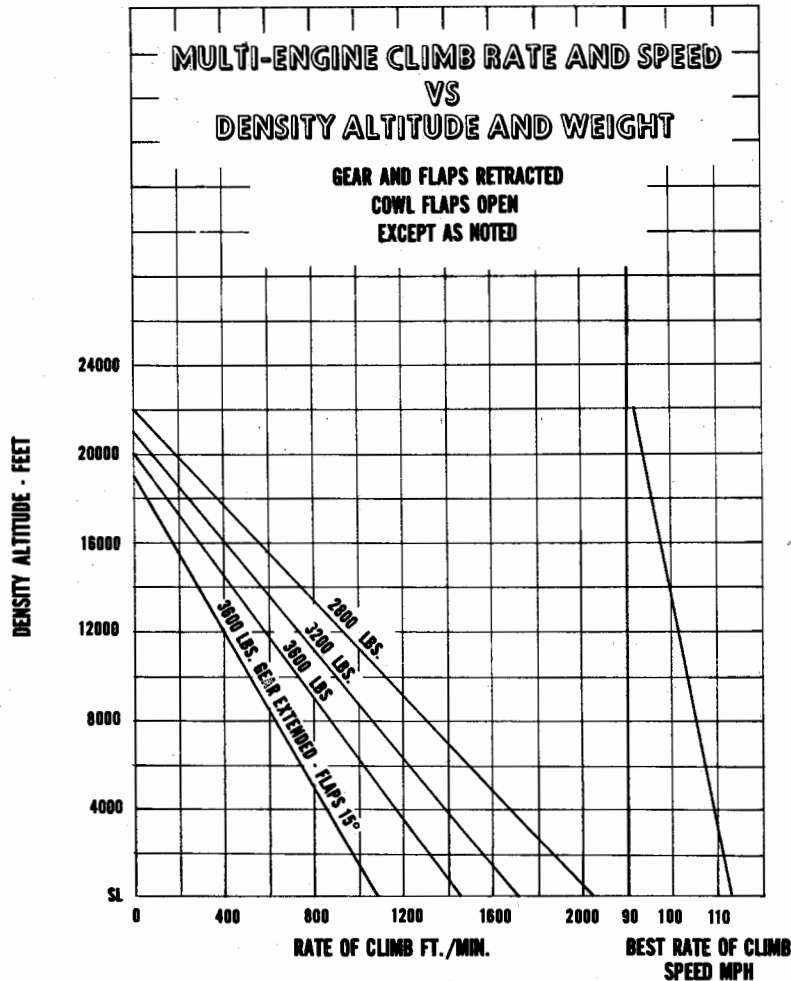

mixture control while operating the auxiliary fuel pump. Before the heater is operated under these conditions, determine that no fuel leaks are present between the tank and engine.

Located in the heater is a heat limit switch, which acts as a safety device to render the heater system inoperative if a malfunction should occur causing excessively high temperatures. This control is located in the downstream end of the vent jacket, with the reset button on the heater shroud. It is reached only through the nose section to insure that the malfunction causing the overheat condition is corrected prior to future heater operation.

To prevent activation of the overheat control during landing roll or while taxiing, turn the three position switch to FAN. During ground operation the manual switch should be on FAN for several minutes to cool the heater before turning to the OFF position.

Ventilating air for the cabin interior is obtained from the two ventilators located at each side of the instrument panel. The rear seat area is furnished with air by overhead vents from the dorsal fin scoop. Each individual vent is adjustable for the desired airflow. Located in the aft section of the cabin is an exhaust vent to improve the circulation of air in the cabin interior.

## SEATS

The front and rear reclining seats are adjustable fore and aft to provide comfort for pilot and passengers. Seat backs may be tipped forward to facilitate ease of entry and exit from the aircraft. They are easily removed by taking out the stops at the end of the mounting tracks and sliding the seats from their tracks.

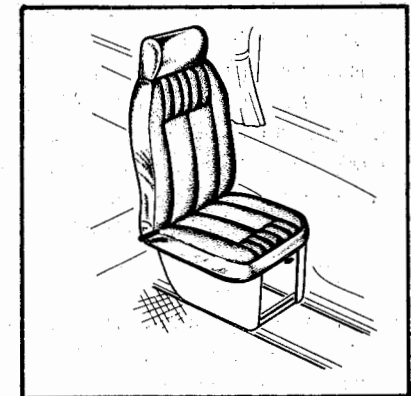

Seat Adjustments

The optional family seat(s) may be removed to allow more baggage area and access to the rear fuselage panel. Release the snap fasteners that attach the seat backs to the hat shelf and turn the wing fasteners at the back of the seat cushions. Vertically adjustable pilots' seats are offered as optional equipment.

## FINISH

All aluminum sheet components are carefully finished inside and outside to assure maximum service life. Both sides of all pieces are alodine treated. External surfaces are coated with durable acrylic lacquer in attractive high gloss colors. The application of primer to interior surfaces prevents corrosion of structural and non-structural parts on the inside of the airplane.

## BAGGAGE AREA

Maximum weight in the baggage area, including baggage, passengers and family seats is 250 pounds, with up to 20 cubic feet of available space. Baggage may be placed in the aircraft through a 19 x 21 inch door or through the passenger entrance. Tie-down straps are available for securing baggage when the family seats are not installed.

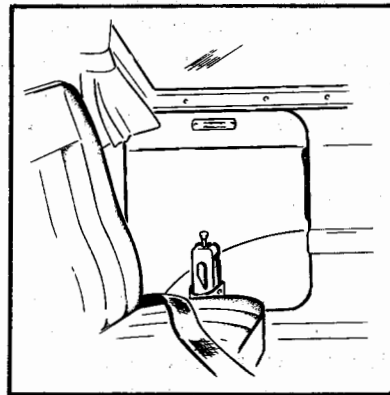

**Baggage-Emergency Door**

The baggage door may also be used as an emergency exit. It is opened by holding the inside door knob up while turning the latch clockwise. For additional baggage compartment loading information refer to page 51.

This page intentionally left blank.



# TWIN COMANCHE

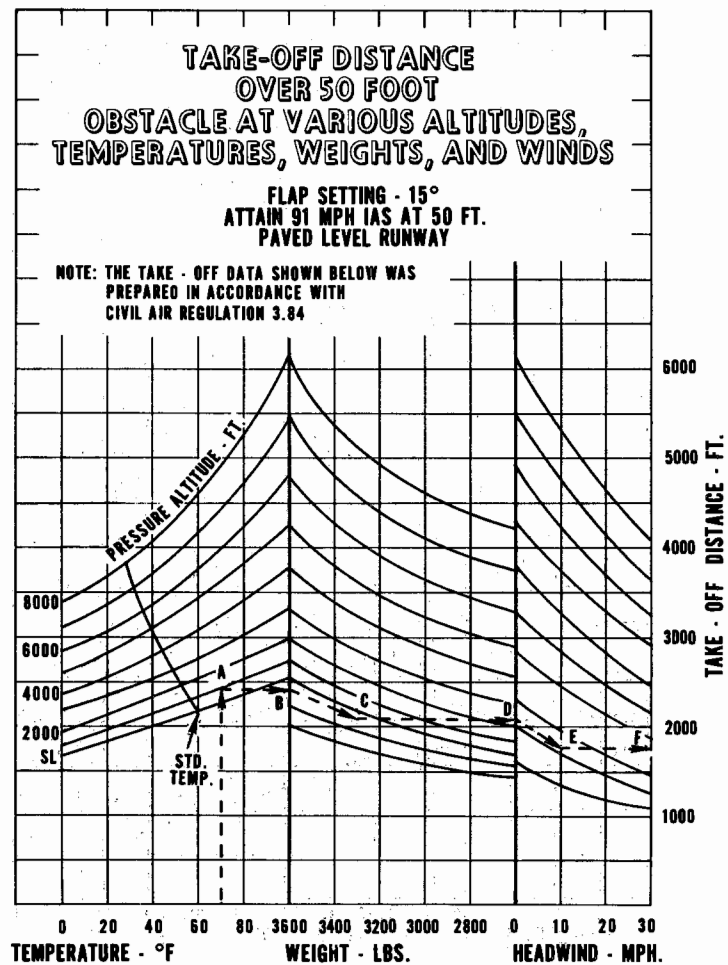

## STALL WARNING SYSTEM

An approaching stall is indicated by both a stall warning light and horn, activated by a lift detector installed on the left wing outboard of the engine nacelle.

This warning horn is separate and operated by a different system from the gear warning horn mentioned on page 9.

# TWIN COMANCHE

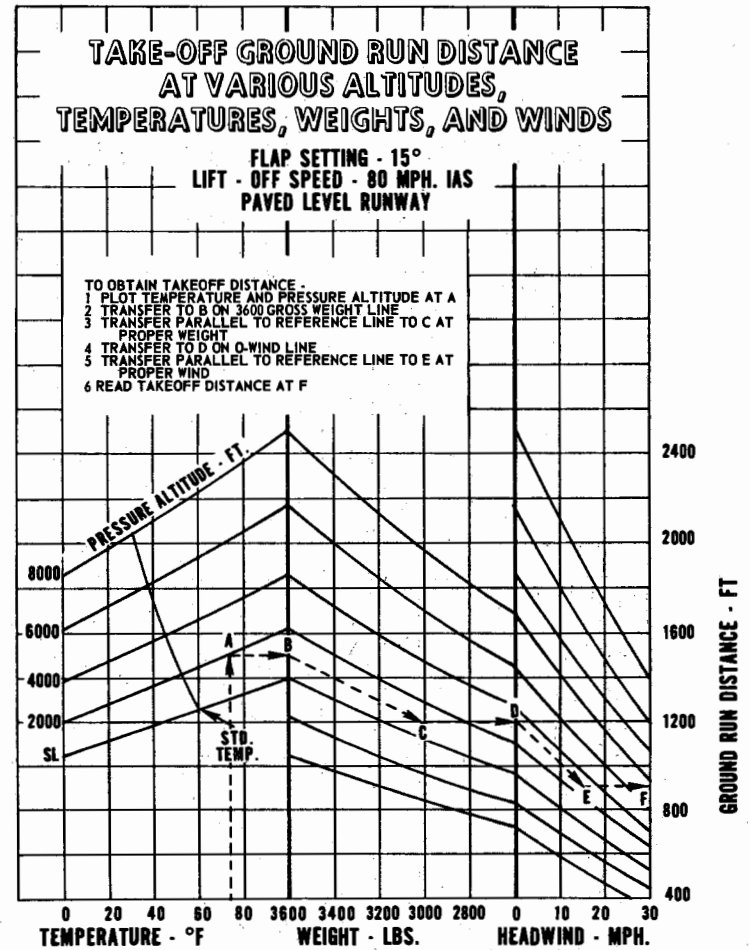

## SECTION III

### OPERATING INSTRUCTIONS

|   |    |
|---|----|
| Preflight . . . . .                       | 25 |
| Starting Engines . . . . .                | 27 |
| Flooded Start . . . . .                   | 27 |
| Warm-Up and Ground Check . . . . .        | 28 |
| Electrical Power . . . . .                | 29 |
| Taxiing and Pre-Take-Off . . . . .        | 29 |
| Take-Off and Climb. . . . .               | 31 |
| Wing Flaps . . . . .                      | 31 |
| Short and Soft Field Take-Offs . . . . .  | 32 |
| Landing Gear Retraction . . . . .         | 33 |
| Deicer Boots . . . . .                    | 33 |
| V <sub>mc</sub> . . . . .                 | 33 |
| Stalls . . . . .                          | 34 |
| Spins . . . . .                           | 35 |
| Spin Recovery Technique . . . . .         | 36 |
| Cruising . . . . .                        | 36 |
| Fuel Management . . . . .                 | 37 |
| Approach and Landing. . . . .             | 39 |
| Post Landing. . . . .                     | 42 |
| Emergency Procedures. . . . .             | 42 |
| V <sub>mc</sub> Demonstration. . . . .    | 49 |
| V <sub>mc</sub> and Stall Speed . . . . . | 50 |
| Mooring . . . . .                         | 50 |
| Loading and Weight and Balance . . . . .  | 50 |
| Operating Tips . . . . .                  | 52 |
| Flight Conditions . . . . .               | 53 |
| Diving Spiral. . . . .                    | 54 |
| Radio Operation. . . . .                  | 55 |

## SECTION IV

### PERFORMANCE CHARTS

|  |    |
|--|----|
| Take-off Ground Run Distance . . . . .                 | 56 |
| Take-off Distance Over 50-Foot Obstacle . . . . .      | 57 |
| Multi-Engine Climb Rate and Airspeed . . . . .         | 59 |
| Single-Engine Climb Rate and Airspeed . . . . .        | 60 |
| Altitude Conversion Chart . . . . .                    | 61 |
| Range vs Density Altitude . . . . .                    | 62 |
| True Airspeed vs Density Altitude . . . . .            | 63 |
| Landing Distance vs Density Altitude . . . . .         | 64 |
| Landing Distance Over 50-Foot Obstacle (Short Field) . | 65 |
| Power Setting Table . . . . .                          | 66 |
| Fuel Flow Indicator . . . . .                          | 67 |

**SECTION III**  
**OPERATING INSTRUCTIONS**

**PREFLIGHT**

The following safety procedure instructions must become an integral part of the pilot's operational routine and preflight inspection.

Begin the preflight inspection in the cockpit. Check that the landing gear selector switch is in the down position. Turn master switch on and check that the green landing gear indicator light is on. If the green light is not on, make sure that the instrument panel light switch is turned to the OFF position. The landing

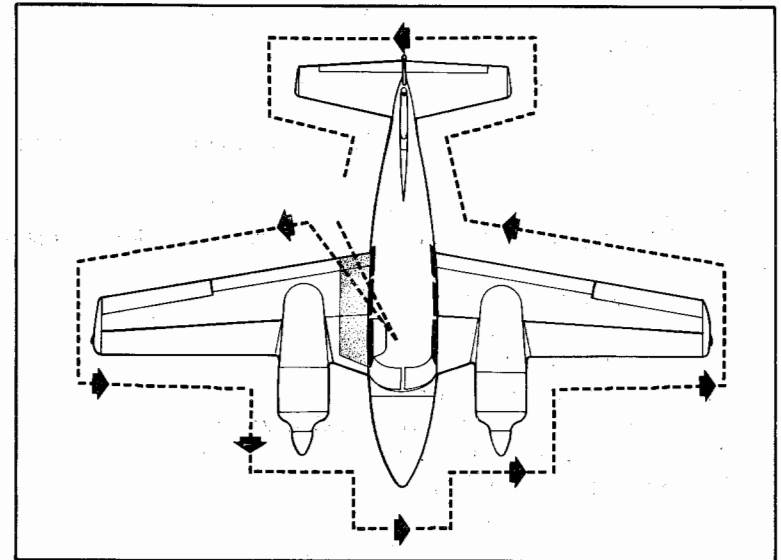

gear indicator light is automatically dimmed and is difficult to see in the daytime if the instrument lights are on.

Drain about a quarter of a pint of fuel from each tank with the cockpit drains before doing the external preflight check. During the external check, determine that the fuel has stopped draining.

During the external preflight check see that the baggage-emergency door is properly secured. Prior to flight, passengers should be briefed about seat belts, the use of oxygen when applicable, how to evacuate the airplane, and advised not to smoke during take-off or landing. They should be cautioned against handling or interfering with essential equipment and flight controls, fuel valves, switches, circuit breakers, trim knobs or cranks, radios etc.

1. Ignition and master switches - OFF.
2. Fuel strainer sump - drained and not leaking.
3. Fuel selectors on main cells.
4. Control surfaces, wing, fuselage - no damage or operational interference.
5. Control surface - free of obstructions, ice and snow.
6. Fuel supply - adequate.
7. Fuel cell caps - secure.
8. Fuel system vents - open.
9. Landing gear struts - 2-3/4" piston exposed under static load.
10. Tires - inflated and not excessively worn.
11. Cowling, landing gear doors, oil and inspection covers - secure.
12. Propellers - check.
13. Oil supply - adequate.
14. Leaks - absent.
15. Windshield - clean and secure.
16. Dorsal fin air scoop - free of obstruction.
17. Control locks - detached.
18. Baggage door - secure.
19. Tow bar - stowed.
20. Cabin controls - operative.

### RADIO OPERATION

Communication and navigational equipment controls are located in the center of the instrument panel. Associated auxiliary switches are located on a separate panel below the control column on the lower right side of the instrument panel. Circuit breakers for the radios are located on the main circuit breaker panel.

All sets are turned "ON" by the switch located on the control head of each particular unit, with the exception of the marker beacon and glide slope power switches which are located on the Audio Selector Switch Panel.

After power is supplied, the pilot may wish to operate one of the two transmitters by moving the transmitter selector switch to the proper position. The switch is located on the selector switch panel.

A separate three position audio selector switch is provided for each receiver. Each receiver audio output may be connected to either the speaker or the headset. In addition they may be placed in the "OFF" or standby position. To receive audio through the speaker from the Marker Beacon and DME the top Mark 12 must be in operation. Power from this radio is not required when the headphones are connected to the Marker Beacon or DME.

Two or more sets may be simultaneously connected to either the headset or speaker position by placing the selector switches in the desired combination. For example, the A.D.F. and the top Mark 12 may be selected to operate on the speaker and the lower Mark 12 may be selected for headset operation. If desired the pilot may listen to the speaker and the co-pilot the headset.

When flying in wet, heavy snow or other conditions where the induction air filters may become clogged, monitor the manifold pressure gauge. A decrease in manifold pressure may indicate a clogged filter. If the decrease is followed by a slight increase in manifold pressure, this will then indicate that the automatic alternate induction air system is in operation, and the manifold pressure may then be brought back to the desired level with the throttle control.

A continued drop in manifold pressure would indicate that the automatic induction air system was not working. In this case, actuate the manual alternate air control, which serves as a back-up for the automatic system. A partial regain of manifold pressure will indicate that the manual alternate air induction system is operating. Throttle controls may be advanced to gain additional manifold pressure.

The manual alternate air control should not be actuated on the ground with the engines operating, because the engines would then be supplied with unfiltered air.

### DIVING SPIRAL

At night or during instrument flying conditions, it is possible for a pilot not proficient at instrument flying to get into an inadvertent steep diving spiral. If a spiral should develop, recover in the following manner:

- a. Reduce power.
- b. Level the wings.
- c. Bring the nose of the airplane to the horizon.

21. Gear selector switch - down.
22. Required papers - in order.
23. Turn master switch on - check stall warning system.
24. Check navigation lights.

### STARTING ENGINES

1. Master switch - on.
2. Gear lights - check green.
3. Fuel quantity - check gauge reading.
4. Cowl flaps - open.
5. Trim tabs - set.
6. Throttles - open 1/2 inch.
7. Propeller controls - forward.
8. Mixtures - rich.
9. Electric fuel pumps - on till indication on fuel flow gauge.
10. Mixtures - idle cut-off.
11. Magneto switches - on.
12. Propellers - clear.
13. Starters - engage.
14. Mixtures - advance.
15. Oil, fuel pressure - check.

### FLOODED START

1. Magneto switches - on.
  2. Throttles - open.
  3. Mixtures - idle cut-off.
  4. Electric fuel pumps - off.
  5. Starters - engage.
- (When engine fires, retard throttle and advance mixture.)

Cranking periods should be limited to 30 seconds with a two minute interval. Longer cranking periods shorten the life of the starter. Do not engage the starter immediately after releasing it as the starter mechanism may be damaged.

**WARM-UP AND GROUND CHECK**

Check the oil pressure as soon as the engines start. If no pressure is indicated within thirty seconds, stop the engine and determine the trouble. If cold temperatures exist (10° F or below), a longer period of time will be necessary before an indication is received.

Warm-up the engines at 1000 to 1400 RPM for not more than two minutes in warm weather and four minutes in cold. The engines are warm enough for take-off when no faltering occurs with the throttle opened. Avoid prolonged idling at low RPM to prevent fouled spark plugs. Check the magnetos with the propeller in low pitch and the engine running at 2200 RPM. The maximum drop on each magneto should not exceed 175 RPM while the differential drop between them should not exceed 50 RPM. Operation on one magneto should not exceed 10 seconds.

Move the propeller controls through their complete range to check feathering action, then leave them in the full forward low pitch position. Feathering action can be checked by running the engine between 1000 and 1500 RPM and pulling the prop control into feather position momentarily. Do not allow a drop of more than 500 RPM and do not feather the propeller when operating at a high manifold pressure with the aircraft on the ground. Propellers should be cycled three times in cold weather.

Cowl flaps permit cooling of the engines by manual control during ground operations or special conditions of flight. It is recommended that cylinder head temperature not exceed 400° F and the oil temperature should not exceed 245° F.

Turn off the electric fuel pumps after starting to make sure that the engine driven pumps are operating. The electric fuel pumps should be on during take-off, landing and when changing fuel selector positions to prevent loss of power at critical times.

13. The shape of the wing fuel cells is such that in certain maneuvers the fuel may move away from the cell outlet. If the outlet is uncovered, the fuel flow will be interrupted and a temporary loss of power may result. Pilots can prevent inadvertent uncovering of the outlet by having adequate fuel in the cell selected and avoiding maneuvers which could result in uncovering the outlet. Running turning takeoffs should be avoided as fuel flow interruption may occur when the main cell selected is less than one-quarter full. Prolonged slips or skids in any pitch attitude or other unusual or abrupt maneuvers which could cause uncovering of the fuel outlet must be avoided when the cell selected is less than one-quarter full.

**FLIGHT CONDITIONS**

Do not fly into marginal or deteriorating weather unless you are equipped and qualified to fly as an instrument rated pilot under instrument conditions. Before taking off on an instrument flight, or a flight at night or in marginal conditions, make sure all instruments and equipment are operating properly.

In mountainous terrain, maintain proper distance from the mountains, especially in strong winds, which may cause extreme downdrafts and turbulence.

Flight should be planned to avoid thunderstorm areas. In conditions of extreme turbulence, reduce power to slow the airplane below the design maneuvering speed of 162 miles per hour.

A further reduction of power will ease the stress to which the airplane is subjected by virtue of turbulence. When flying in extreme turbulence or strong vertical currents, using the autopilot, the altitude-hold mode should not be used.

Flying over 10,000 feet without using supplemental oxygen should be avoided.

Do not takeoff with ice or frost on the wings, as ice or frost will radically change the flight conditions of the airplane.

The deicing equipment on light twins, if installed, is designed to allow the pilot to fly out of inadvertent icing situations, not to handle heavy icing. Even if the airplane is equipped with deicing equipment, do not plan to fly in any icing condition. Deicing equipment should be checked in accordance with the Airplane Flight Manual instructions prior to entering known icing conditions.



## OPERATING TIPS

1. Trim for takeoff so that a light back pressure on the control wheel allows the airplane to lift from the runway.
2. When checking the propeller feathering action, it is necessary to move the propeller control rapidly in and out of feathered position to prevent a drop of more than 500 RPM. Excessive manifold pressure will occur if the RPM count falls below 1000 during this check.
3. Do not retract the landing gear prematurely on takeoff.
4. To reduce wing flap operating loads, lower the wing flaps at airspeeds well below 125 miles per hour.
5. Determine the position of the landing gear by checking the gear position lights.
6. During landing, allow the main wheels to contact the ground while centering the rudder pedals. Apply additional back pressure to the control wheel and retract the wing flaps for good directional control and maximum effectiveness of brakes during landing roll.
7. When the instrument lights are on, the gear position lights are dimmed for night flight.
8. Be sure that all radio switches, light switches and pitot heat switch are in the off position before starting engines.
9. Due to the responsive trim tab controls, a small adjustment in trim gives a rapid change in attitude.
10. Engine shut down by use of the mixture controls may cause a rough stop during high ambient temperature conditions. A spring loaded device on the throttle will shut down the engines by closing the throttle valves and shutting off air to the engines. As this mechanism is connected to and operated by the last 1/8 inch travel of the throttles, a stop on the quadrant prevents the throttles from being pulled fully aft and closing the throttle valves.
11. This throttle cut-off is not intended to be used in lieu of the mixture control for engine shut down: it is to be used only when the mixture control is placed in idle cut-off and there is indication of a rough stop.
12. During single engine flights be sure that the gear and flaps are fully retracted when climbing at the best single engine climb speed. Speeds above or below the best single engine climb speed will decrease climb performance. Close the cowl flap on the inoperative engine and trim the airplane to reduce drag.

## ELECTRICAL POWER

Do not attempt flight with a very low charged battery.

## CAUTION

Be sure to have the generators turned on. If the battery charge is low and generators are not operating, an inadvertent gear-up landing is possible because the warning horn and flashing light will not operate and the landing gear cannot be extended electrically. Manual extension of the landing gear is required under these circumstances.

## TAXIING AND PRE-TAKE-OFF

Start to move the airplane forward. During initial taxiing, throttle back and apply brakes to check their operation. Use differential power and nose wheel steering rather than brakes when taxiing. Retard the throttle to the engine on the inside of turn and advance the throttle to the engine on the outside of the turn.

The autopilot should be off before take-off.

On a cold day test defroster and cabin heater before take-off. Do not fly in cold weather when the heater is inoperative, as the windshield may become frosted.

Lock the door before take-off. If this item is neglected and the door comes open after take-off, maintain normal climb and airspeed until sufficient terrain clearance is obtained. (Do not risk loss of control of the airplane to close the door. It is possible to continue safely for extended periods with the door unlatched.) When it is impossible to land straight ahead, the door may sometimes be closed by the following procedure: slow the airplane to 100 miles per hour; lower landing gear and wing flaps; open the small window to the left of the pilot; pull the door shut and lock it.

Check list:

1. Parking brake - on.
2. Engine run-up
  - (a) Mixture controls - forward.
  - (b) Propeller controls - forward.
  - (c) Throttle controls - forward (1500 rpm).
  - (d) Propeller controls - exercise.  
Check feather; 500 rpm maximum decrease.
  - (e) Throttle controls - forward (2200 rpm).
  - (f) Magnetos - check.  
Normal drop - 100 rpm  
Maximum drop - 175 rpm  
Differential drop left to right - 50 rpm
3. Engine gauges - check green.
4. Lights (as required) - on.
5. Pitot heat (as required) - on.
6. Transponder - stand-by.
7. Flaps - set.
8. Gyro pressure - 4.8 to 5.1 in. Hg.
9. Directional Gyro - set.
10. Turn & Bank - operating.
11. Altimeter - set.
12. Clock - wind & set.
13. Generators - on.
14. Electric fuel pumps - on.
15. Door - locked.

remains within the allowable weight vs center of gravity envelope while in flight. The owner or pilot must determine before each flight that the gross weight is not exceeded and that the center of gravity is within allowable limits. For weight and balance see the Airplane Flight Manual and Weight and Balance form supplied with each airplane.

Weight and balance determination should be accomplished with the Weight and Balance Plotter supplied with the airplane.

The airplane can carry six passengers with less than the full fuel capacity of 90 gallons (without wing tip tanks) and less than the allowable baggage. The two rear family seats, if installed, are designed and placarded to carry not more than 235 lbs. total. With these two rear family seats removed, the area remaining (baggage) will carry up to 250 lbs. depending upon airplane loading. It will carry fewer passengers and baggage with full fuel tanks. As with any airplane, improper loading will cause undesirable flight characteristics if the airplane approaches a critical or marginal flight condition.

Make sure that baggage and/or cargo are secured properly with tie down straps to avoid an accidental in-flight shift of the center of gravity or injury to passengers.

With tip tanks installed, the airplane has an allowable gross weight of 3725 pounds. It is important to remember that any weight in excess of 3600 pounds however, must be in the form of fuel in the tip tanks.

**V<sub>MC</sub> AND STALL SPEED**

More power is available on the operating engine at lower altitudes (if the engine is normally aspirated) and hence there can be more asymmetric thrust. The  $V_{MC}$  is highest at low altitudes. The  $V_{MC}$  decreases with altitude and at higher altitudes the airplane will approach a stall speed before reaching  $V_{MC}$ . The most critical situation occurs at the altitude where the stall speed and  $V_{MC}$  speed coincide. Care should be taken to avoid this flight condition because at this point loss of directional control could lead to a spin.

**MOORING**

The airplane should be moved on the ground with the aid of the nose wheel towing bar provided with each plane. The tow bar is stowed on the forward side of the main spar within the cabin.

Tie down ropes for mooring the airplane can be fastened to the wing tie down rings and tail skid.

The aileron and stabilator controls should be secured by means of a safety belt or control locks to prevent control surface damage. The rudder is held in position by its connections with the steerable nose wheel and does not need to be secured except under unusually high wind conditions.

**LOADING AND WEIGHT AND BALANCE****CAUTION**

It is the responsibility of the owner and pilot to determine that the gross weight of the airplane is not exceeded and to determine that the airplane

The normally recommended setting for sea level take-off is full throttle at 2700 RPM. The slightly rich mixture for this setting aids in cooling the engine.

**TAKE-OFF AND CLIMB**

- |  |  |
|--|--|
| 1. Parking brake - off                         | 8. Flaps - retracted   |
| 2. Mixtures - forward                          | 9. Climb power - set<br>(At approx. 400 AGL)                         |
| 3. Propellers - forward                        | 10. Cowl flaps - set<br>(Maintain cyl. hd. temp.<br>at or below max) |
| 4. Throttles - forward                         | 11. Oxygen - no smoking - on<br>(10,000 ft & above)                  |
| 5. Accelerate to - 90 MPH<br>(Prior to climb)  |  |
| 6. Landing gear - retract                      |  |
| 7. Accelerate to - 112 MPH<br>(Best R/C speed) |  |

During take-off roll apply light back pressure to the control wheel to avoid porpoising during the take-off run. Accelerate to single engine minimum control speed ( $V_{MC}$ ) before applying stronger back pressure for rotation.

During normal conditions, retraction of the landing gear should occur when a gear down landing is no longer possible on the runway. Attain the best rate of climb speed and at least 400 feet above ground level before reducing power.

**WING FLAPS**

Wing flaps are not necessary for take-off except when operating from a short or soft field. The use of wing flaps during take-off in a lightly loaded airplane may cause the airplane to lift-off the runway before  $V_{MC}$  is attained. An effort to hold the airplane on the runway too

long may result in a "wheelbarrowing tendency" with most of the weight on the nose wheel.

Wing flaps are not normally used during a crosswind take-off. After lift-off set up the required crab angle, retract the gear at a safe altitude and continue climb out.

An en route climbing speed of 130 miles per hour is recommended for increased forward visibility during continuous climb.

#### SHORT AND SOFT FIELD TAKE-OFFS

If it is necessary to get the airplane off the runway in the shortest possible distance, set take-off wing flaps (with the flap position needle at the bottom of the white arc on the flap indicator). With brakes set, run up engines to maximum power and check instruments. If the airplane is off the runway at less than 90 miles per hour, it is essential to fly level a few feet off the runway immediately after lift-off until reaching 90 mph. After airspeed has increased, initiate a climb at the best angle of climb speed (90 mph at sea level) if an obstacle is to be cleared, or at the best rate of climb speed (112 mph at sea level) if a normal climb out is desired. Since the airplane cannot be controlled in flight below  $V_{mc}$  in the event of the sudden power loss in one engine, be ready to reduce power promptly.

#### NOTE

Take-off at high altitude (density altitude), from a soft, wet, rough or grassy field, or with an uphill gradient or tail wind component results in greatly reduced take-off performance.

During take-off roll, check to be sure the airspeed indicator is operating properly. The needle should indicate zero when the airplane is at rest.

shaft slot, then push the parts together.

- f. Lock the drive shaft to the torque tube by pulling the motor release arm full back to the normal locked position.
- g. Disengage the extension handle and return to stowage.
- h. Check gear for proper operation.

#### 5. Gear-Up Landing:

An emergency gear-up landing may be necessary under the following conditions:

- a. If surface is too soft or rough for gear down landing.
- b. When the field is too short for a gear down landing.
- c. When a water landing is necessary.

During a gear-up landing use a normal flaps up approach. During flare out close the throttles, shut off the master and ignition switches, turn fuel selectors off and contact the ground at minimum speed.

#### $V_{MC}$ DEMONSTRATION

#### WARNING

The engine-out minimum control speed demonstration required for the FAA flight test for the multi-engine rating approaches an uncontrolled flight condition with power reduced on one engine. The demonstration should not be performed at an altitude of less than 3500 feet above the ground. APPROACH  $V_{MC}$  WITH CAUTION. Initiate recovery during the demonstration by immediately reducing power on the operating engine and promptly lowering the nose of the airplane.

disengage control located between the two front seats, and follow the instructions on the back of the cover as follows:

- a. Airspeed not over 100 MPH.
- b. Landing gear switch in center off position if landing gear switch is a three position or in the gear down locked position if switch is a two position.
- c. Disengage Motor - Raise motor release arm and push forward thru full travel.
- d. Remove gear extension handle from stowage. If left socket is not in clear position, place handle in right socket. Engage slot and twist clockwise to lock handle. Extend handle and rotate forward until left socket is in clear position. Remove handle and place in left socket. Lock and extend handle. Rotate handle forward full travel to extend landing gear. Green light on panel indicates landing gear down and locked.

After the gear has been extended manually, do not perform any unnecessary operation to the gear until the aircraft is placed on jacks.

#### NOTE

Reducing power and rocking gear extension handle will aid in manually extending the landing gear.  
**DO NOT RETRACT WITH HANDLE IN SOCKET.**  
**DO NOT RE-ENGAGE MOTOR IN FLIGHT.**

Given below is the procedure for returning the gear to normal electric operation:

- a. Place aircraft on jack.
- b. Landing gear circuit breaker should be disengaged.
- c. Pull landing gear emergency extension handle about half way back, allowing gear to hang partially retracted.
- d. Re-engage circuit breaker and with landing gear control switch move end of the electric motor drive shaft into position about half way back so that the slot in the drive shaft is near the mating pin on the torque tube.
- e. Using the extension handle move the torque tube pin slightly back and forth until it can be engaged with the drive

#### LANDING GEAR RETRACTION

Make sure the aircraft has sufficient altitude and airspeed with no chance of settling back on the runway before retracting the gear. When taking off from a long runway, retract the landing gear when it would no longer be possible to land straight ahead.

#### DEICER BOOTS

If your Twin Comanche is equipped with deicer boots, they should not be operating during take-off since inflated boots can change the stall characteristics of the airplane.

#### V<sub>MC</sub>

V<sub>mc</sub> (Velocity minimum control) is the calibrated airspeed, determined by FAA test pilots, below which a twin engine aircraft cannot be controlled in flight with one engine operating at take-off power and the other engine windmilling. The V<sub>mc</sub> which the FAA has determined for the Twin Comanche is 90 mph CAS.

Calibrated airspeed is equal to the airspeed indicator reading corrected for position and instrument error. Since calibrated airspeed and density altitude and pilot flight techniques vary, it is best, especially when heavily loaded or on a cold day, to fly the aircraft as though V<sub>mc</sub> were slightly higher.

Under no circumstances should the aircraft be flown below the V<sub>mc</sub> of the aircraft with one engine operating at maximum power and the other engine windmilling. When operating under single flight conditions, either in training or in emergency situations, maintain indicated airspeed above 97 mph.

#### APPROACH V<sub>MC</sub> WITH CAUTION

On take-off the aircraft should be kept either on, or near the runway, until reaching V<sub>mc</sub>. After V<sub>mc</sub> has been reached the air-

craft should be accelerated as rapidly as possible to the best rate of climb speed (112 mph) if there are no obstacles ahead. If there are obstacles ahead maintain the best angle of climb speed (90 mph). The applicable speed should be maintained until all obstacles are cleared and the airplane gains sufficient altitude.

## STALLS

### WARNING

Do not perform asymmetric power stalls or single engine stalls. Do not perform symmetrical power-on stalls unless maneuver is initiated at least 5000 feet above terrain and with not more than pilot and copilot aboard except during flight checks.

The left wing on the Twin Comanche with clockwise rotating propellers will, generally speaking, under conditions of moderate symmetrical power, stall more rapidly than the right wing, and if recovery is not promptly initiated, the airplane will have a tendency to roll to the left.

As in any multi-engine aircraft, stall recovery in the Twin Comanche should be initiated at the first indication of a pre-stall buffet, warning light or horn. The aircraft should not be permitted to develop into a full stall.

engine rated pilot who is familiar with the Twin Comanche characteristics and procedures.

For most single-engine practice it is recommended that the reduction of drag accomplished by feathering a propeller be simulated by a power setting of 10 inches of manifold pressure and 2200RPM. This will accomplish a zero thrust on the selected engine.

Under the proper conditions, actual propeller feathering may be practiced. The following precautions should be exercised when an engine is feathered for practice.

- a. Do not feather a propeller for practice if you think the engine may be difficult to restart.
- b. Do not feather a propeller for practice at a low altitude above the ground.
- c. Do not feather a propeller for practice with a low charged battery, as it takes electrical power to get the engine started.
- d. Do not feather a propeller for practice unless you are within reasonable distance of an airport.
- e. Do not feather a propeller for practice in conditions of temperature, altitude, weight or turbulence which may prevent single-engine flight at altitudes well above the ground elevations.

#### 4. Manual Gear Extension:

Manual landing gear extension is accomplished with the mechanism located under the floorboard directly aft of the nose wheel housing. This system is used only to extend the gear if the electrical actuating system has failed and not to retract the gear manually without the use of the electric motor. With the electric motor disengaged from the gear torque tube, as required in extending the gear manually, there is no mechanism for holding the gear in the "UP" position so that the gear will not stay up if retracted manually.

Before proceeding with emergency gear extension, check the following:

- a. Master and gear circuit breakers are in.
- b. Master switch is on.
- c. Navigation lights are off (daytime).

To extend the gear, remove the cover over the emergency

## 2. Feathering:

The Hartzell HC-E2YL-2 feathering propellers can be feathered only while the engine is rotating above 1000 RPM. Loss of centrifugal force due to slowing RPM will actuate a stop pin that keeps the propeller from feathering each time the engine is stopped on the ground. If an engine freezes up, it will be impossible to feather its propeller. Single engine flight with the propeller of the inoperative engine unfeathered will decrease single engine performance.

## 3. Unfeathering:

It is not recommended that propeller feathering and unfeathering be practiced on the ground because of the excessive vibration that occurs in the engine installation. In flight, feathering should be practiced only to familiarize the pilot with the proper procedures. To unfeather a propeller in flight, the following technique is recommended:

- a. Ignition switches ON.
- b. Mixture RICH.
- c. Throttle open about 1/2 inch.
- d. Prop control at cruise setting.
- e. Engage starter until engine starts.
- f. Allow engine to idle at 1000 to 1500 RPM until oil temperature begins to rise. Adjust to cruising power when engine warms.

The Twin Comanche, operating under optimum conditions of turbulence and pilot technique, and under standard conditions of temperature and pressure, has a single engine service ceiling of 5800 feet at 3600 pounds gross weight and maximum continuous power.

During initial multi-engine training and in order to maintain subsequent proficiency, it is desirable to practice single-engine flight. Such practice is not advisable with passengers aboard the airplane, with a heavy load, or with extreme rearward center of gravity. In no case should single-engine operation be practiced without having in one of the pilot's seats a well-qualified twin-

## CAUTION

Use controls promptly to counteract any rolling or yawing action of the airplane during the approach to and recovery from the stall. The stall warning system is inoperative if the master switch is off.

## NOTE

An increase in bank angle increases the stalling speed.

STALL SPEED TABLE (CAS)

| Angle of Bank | Gear & Flaps Up | Gear & Flaps Down |
|---------------|-----------------|-------------------|
| 0°            | 76              | 69                |
| 20°           | 79              | 71                |
| 40°           | 87              | 79                |
| 60°           | 108             | 98                |

These figures are at gross weight of 3600 pounds with power off.

## SPINS

The Twin Comanche is FAA approved in the normal category, and in this category all intentional acrobatic maneuvers, including spins, are prohibited. Spins and other intentional acrobatic maneuvers, may subject the airplane to stresses beyond which it was designed.

**SPIN RECOVERY TECHNIQUE**

In the event of an inadvertent spin, recovery can be accomplished in the following manner:

1. Retard both throttles to idle position.
2. Apply full rudder in the opposite direction to the spin.
3. Push control wheel full forward. While it is not necessary for recovery, the use of ailerons against the turn (ie. right aileron if spin is to left) will expedite recovery. Maintain controls in these positions until the spin stops. Then, neutralize rudder and ailerons.
4. Recover from dive with smooth back pressure on control wheel. No abrupt control movement should be used during recovery from the dive.

**NOTE**

Altitude loss in a spin may be in excess of 2000 feet. Avoid any maneuver which might result in a spin at low altitude. The more rapidly spin recovery is begun the more prompt the recovery will be.

**CRUISING**

The cruising speed of the Twin Comanche is determined by many factors including power setting, altitude, temperature, weight, and equipment installed.

The normal recommended economy cruising power setting of the Twin Comanche is at 65% power. At 12,000 feet this gives a True Airspeed of 186 MPH. This power setting is obtained under standard conditions at 2400 RPM and full throttle. Fuel consumption is approximately 15.2 gallons per hour total.

The optimum cruising speed of the Twin Comanche at 8000' is 194 MPH. (See Power and Performance charts for power settings and performance under various conditions.)

The Lycoming engines on the Twin Comanche can be cruised at any percent of power from 75% down. 2400 RPM is recommended for maximum cruise performance and lower RPM's, down to 1800, for more economical cruising conditions. Ordinarily an RPM setting should be selected which will give maximum smoothness.

If single engine go-around cannot be avoided, the landing gear and wing flaps should be retracted as soon as possible after application of full power, since under most conditions, climb, or even level flight, is impossible during single engine operation with landing gear and wing flaps extended.

**CAUTION**

If rudder trim has been used to ease single engine control pressures, the trim should be adjusted as the throttle control is retarded for final approach and landing.

**RECOMMENDED PRACTICE**

When operating single engine maintain speed above 97 mph. This speed, 97 mph, will not provide optimum single engine climb performance. Optimum single engine climb is obtained at the best single engine rate of climb speed, 105 mph, with the operating engine at full throttle, 2700 rpm and the inoperative engine propeller feathered and cowl flap closed. The gear and flaps must be retracted.



the propeller pitch control into the feather position. The mixture should then be moved to idle cut-off and ignition turned off.

Reduce power on the operating engine if altitude and loading are such that adequate performance can be maintained on one engine and then reduce the electrical load.

Best single engine performance will be obtained with the wing on the side having the inoperative engine held about three to five degrees higher than level to help counteract the tendency to turn in that direction. Rudder trim may be used to correct for additional control pressure needed in single engine flight.

(c) Single Engine Approach:

As the airport is approached for landing, reduce power on the operative engine and gradually retrim the rudder. When it is obvious that the airport can be reached, lower the landing gear and check the indicators to make sure landing gear is down and locked.

During a single engine approach the landing gear should not be lowered until landing is assured. It is important, however, to extend the landing gear soon enough that there will be time to lower it manually in the event of a landing gear malfunction, and also so there will be no great change in airplane configuration just prior to landing.

Maintain additional altitude and speed during approach, keeping in mind that landing should be made right the first time and that a go-around may require the use of full power on the operating engine, making control more difficult.

A final approach speed of 105 miles per hour and the use of half rather than full wing flaps will place the airplane in the best configuration for a go-around should this be necessary, but it should be avoided if at all possible. It is essential to land the airplane the first time on a single engine approach in order to avoid the need for a go-around. Under some conditions of loading or density altitude a go-around may be impossible, and in any event the sudden application of power during single engine operation may cause control difficulties.

To avoid undesirable stresses on the propellers and the possibility of detonation in the engine, no manifold pressure settings over 25" should be used with an RPM of less than 2000.

To obtain the desired power, set the manifold pressure and RPM according to the power setting table in this manual. After the desired power settings have been set up, adjust the mixture control for corresponding best power setting as indicated by the fuel flow meter. The low side of the power setting, as shown on the fuel flow meter, indicates best economy for that percent of power while the high side indicates best power.

During climbing operation the servo regulator will sense the change in altitude and will automatically lean the mixture. For better economy, manual leaning with the mixture control can also be accomplished if desired. When desired altitude is reached, electric fuel pumps may be switched off.

### FUEL MANAGEMENT

Fuel should be used from the main fuel cells during take-off, landing, climb and descent. Auxiliary fuel and tip tank fuel is to be used in level flight only.

The electric fuel pumps should be on during take-off, landing and while switching tanks in order to prevent loss of power at critical times.

In turning off the electric fuel pumps allow a time delay of approximately 20 seconds between switching each of the fuel pumps off in order to insure that the engine driven pumps are operating properly.

Since a fuel injected engine such as is used on the Twin Comanche takes an appreciable length of time to start after fuel starvation, it is recommended that you avoid emptying a fuel cell to depletion. If the engine should stop because a fuel cell is depleted of fuel be prepared to wait a while for the engine to start after changing to a fuel cell with fuel in it. If it is necessary to use all the fuel in a fuel cell, carefully monitor the fuel flow meter and quickly change the fuel valve position at the first indication of a decrease in fuel flow. This will enable you to keep the engine operating while using all of the fuel in the fuel cell.

**CAUTION**

If tip tanks are installed on the airplane and if the tip tanks have been run completely dry in flight, air may be trapped in the line from tip tank to solenoid valve when tip tanks are subsequently filled. The air pocket in the line may prevent immediate feeding of fuel from tip tanks. To avoid this condition, purge air from lines prior to starting of aircraft.

1. Turn fuel selector valve to "AUX" position.
2. Turn on aircraft master switch and place tip tank fuel selector switch to tip tank position. Ascertain that tip tank solenoid switch, under fuel console, is operating by listening for a slight click when switch is operated.
3. Lift up appropriate fuel drain valve and allow fuel to drain. Observe for flow in clear plastic tube, followed by interrupted flow of no fuel for a few seconds, further followed by a bubbling flow then full flow. Total drain time should not be less than 30 seconds.
4. Procedure shall be accomplished for each tip tank separately.
5. In addition to above procedure operate the the power plant from each wing tip separately until steady fuel flow is assured during ground runup prior to flight.

If not properly inspected and maintained, the bladder-like fuel cells of the airplane could partially collapse, causing the fuel gauging system to be inaccurate. The tanks and gauging system, therefore, should be inspected in accordance with Piper service instructions and kept in good condition.

During flight, keep account of time and fuel used in connection with power settings to determine how the fuel flow and fuel

ture, propeller and throttle controls are full forward and landing gear and wing flaps are up. If enough altitude has been reached before the failure occurred, or if performance is satisfactory for reaching the airport with landing gear extended, leave the landing gear in the down position.

Make positive identification of inoperative engine by gently throttling back on suspected engine. If no effective power is being delivered by that engine, feather the propeller, and trim directionally with rudder trim.

Climb straight ahead to traffic pattern altitude and return to airport for landing.

Do not try to turn or climb too sharply. Turns, however, can be made toward the inoperative engine if necessary.

**NOTE**

A climbing turn toward an inoperative engine is more critical than a gliding turn toward an inoperative engine because there is more asymmetric thrust with the power setting used for climb. Trim directionally with rudder trim.

**(b) During Cruise Flight:**

If engine failure occurs during cruise flight, maintain airspeed and directional control of airplane; immediately advance mixture, propeller and throttle controls. The airplane will yaw in the direction of the inoperative engine. It will rarely be possible to immediately locate the inoperative engine by viewing the manifold pressure gauge. This yaw in the direction of the inoperative engine can be corrected with rudder and rudder trim.

Carefully retard the throttle control of the suspected inoperative engine in order to identify the malfunctioning engine and verify that it is not producing power. Turn on fuel pumps, check ignition switches, fuel gauges and fuel cell selectors and try to determine cause of the engine failure. If power cannot be regained, the propeller on the inoperative engine should be feathered by retarding the throttle to the idle position and moving

**POST LANDING**

## Check list:

- |                      |                             |
|----------------------|-----------------------------|
| 1. Flaps - retract   | 3. Electric fuel pump - off |
| 2. Cowl flaps - open | 4. Prop controls - forward  |

When completely stopped in a parking spot, check the following items for shut down:

- |                               |                        |
|-------------------------------|------------------------|
| 1. Radio & elec. equip. - off | 5. Master switch - off |
| 2. Heater (if used) fan - off | 6. Parking brake - on  |
| 3. Mixtures - idle cut-off    | 7. Generators - on     |
| 4. Magneto switches - off     |                        |

If control locks are not available and the airplane is to be left for more than a few minutes, secure the control wheel with the safety belt strap. Chock the wheels and secure tie downs at appropriate places.

**EMERGENCY PROCEDURES**

## 1. Engine Failure:

## (a) During Take-off Or After Lift-off:

If an engine failure occurs during take-off run prior to lift-off with adequate stopping distance remaining, reduce the power on both engines and stop the airplane straight ahead.

If an engine failure occurs after lift-off with adequate landing distance ahead, immediately reduce the power on both engines and effect a landing.

If engine failure occurs during climb out after take-off, maintain directional control with rudder and ailerons, and establish the best single engine rate of climb airspeed (105 mph at sea level). Speeds below or above the best rate of climb speed will result in lower than optimum rate of climb. Check that mix-

quantity gauging systems are operating. If the fuel flow indication is considerably higher than the fuel actually being consumed or an asymmetric flow gauge indication is observed, you may have a clogged fuel nozzle which should be cleaned.

**APPROACH AND LANDING**

Prior to extending the landing gear for landing, retard both throttle controls to check that the landing gear warning horn is operating. Flying the airplane with the horn inoperative is not permitted. It can lead to a gear up landing as it is easy to forget the landing gear when approaching for a single engine landing when other equipment is inoperative or when attention is drawn to events outside of the cockpit. Therefore it is especially important to check that the landing gear is down when there is any distraction in the landing situation.

Lower the gear at speeds below 150 miles per hour and the flaps at speeds below 125 an hour.

**CAUTION**

Maintain sufficient speed during turns in the traffic pattern. It is a good practice to trim the aircraft to establish a speed of at least 115 miles per hour on the downwind leg and 110 miles an hour on the base leg. Hold 110 miles per hour until the turn onto final approach has been completed. Then reduce to a final approach speed at 100 miles per hour.

Set the propeller at a high cruising RPM of at least 2400 RPM for ample power if a go-around is necessary. Mixture control should be in the full rich

position unless density altitude or conditions of high temperature and humidity dictate otherwise.

Avoid steep turns at low airspeeds or at low altitudes, particularly during the turn from base leg to final approach.

Ascertain the landing gear is down and locked on base leg or final approach, by checking the green indicator light on the instrument panel.

The degree of wing flap extension and touch down speed vary with conditions, but under normal conditions full wing flaps (27 degrees) should be used during the final approach and landing to reduce stall speed and to permit contact with the runway at a slower speed.

Contact the ground at the minimum speed consistent with landing conditions.

For short, slow landings under normal conditions use full wing flaps, partial power, and hold the nose up as long as possible before and after contacting the ground with the main wheels.

In high winds and crosswinds, it is desirable to approach a landing at higher than normal speeds with half or no wing flaps. If a go-around is necessary apply full throttle, retract the landing gear, and slowly retract the wing flaps.

During a crosswind approach hold a crabbed angle into the wind until ready to flare out for the landing. Then lower the wing that is into the wind, reduce crabbed angle, and keep the wheels aligned to the runway using rudder.

#### NOTE

Landings with a crosswind component greater than 20 miles per hour should be avoided.

When extending or retracting wing flaps, do so a few degrees at a time to avoid an asymmetrical flight condition which would

result if one wing flap should stick.

Do not side slip with wing flaps extended.

Avoid prolonged side slip with a fuel selector set to a fuel cell with low fuel indication.

Prior to landing and early in the roll out the brakes should be checked for operation. After landing maximum braking is achieved by retracting wing flaps and pulling back on the control wheel as wheel brakes are applied.

#### CAUTION

It is possible for a pilot to inadvertently reach for the landing gear selector switch instead of the wing flap switch while there is still enough lift on the wings to keep full weight of the airplane off the wheels and thus prevent the actuation of the landing gear safety mechanism, causing retraction during the landing roll. If additional braking is not needed, the wing flaps should be retracted after the airplane has been maneuvered to a stop off the runway. If a landing must be made without wheel brakes the airplane should be flown to contact the ground at a slower speed and landed short on the longest available runway.

The procedure for manually lowering the landing gear should be memorized and understood completely so that it can be accomplished quickly in an emergency situation, such as a single engine landing. (Refer to Emergency Procedures, in this section for manually lowering the landing gear.)

Landing check list:

1. Mixtures - rich.
2. Electric fuel pumps - on.
3. Fuel selectors on proper tanks.
4. Propellers at high cruising rpm.
5. Landing gear - down (under 150 mph) - check green.
6. Flaps (under 125 mph) - set.

## SECTION II

### DESIGN INFORMATION

|   |    |
|---|----|
| Engine and Propeller . . . . .              | 6  |
| Fuel Injection . . . . .                    | 7  |
| Structures . . . . .                        | 8  |
| Landing Gear . . . . .                      | 8  |
| Control System . . . . .                    | 10 |
| Fuel System . . . . .                       | 11 |
| Electrical System . . . . .                 | 14 |
| Vacuum System . . . . .                     | 16 |
| Instrument Panel . . . . .                  | 17 |
| Instrument Static Pressure System . . . . . | 20 |
| Heating and Ventilating System . . . . .    | 21 |
| Seats . . . . .                             | 22 |
| Finish . . . . .                            | 23 |
| Baggage Area . . . . .                      | 23 |
| Stall Warning System . . . . .              | 24 |

**SKETCH A**

**SKETCH B**

**SKETCH C**

**SKETCH D**

**SKETCH E**

**SKETCH F**

**SKETCH G**

**SKETCH H**

**SKETCH I**

**FREQUENCY**

DAILY 50 100 500 AS REQUIRED

**METHOD**

HAND OR PACK OIL CAN GREASE GUN SPRAY CAN BRUSH HYDRAULIC FLUID

| EXAMPLE   | TYPE OF LUBRICANTS    | SPECIAL INSTRUCTIONS   |
|---|-----------------------|--|
| METHOD OF LUBRICATION   | IDENTIFICATION LETTER |  |
| <p><b>FREQUENCY OF LUBRICATION</b></p> <p><b>TYPE OF LUBRICANT</b></p> <p><b>SPECIAL INSTRUCTIONS</b></p> <p><b>LUBRICATION CHART PA-30</b></p> | A                     | MIL-L-7870 LUBRICATING OIL, GENERAL PURPOSE, LOW TEMPERATURE   |
|   | B                     | MIL-L-6082 LUBRICATING OIL, AIRCRAFT RECIPROCATING ENGINE (PISTON GRADE AS SPECIFIED)<br>SAE 50 ABOVE 60° F AIR TEMP.<br>SAE 40 30° TO 70° F AIR TEMP.<br>SAE 30 0° TO 70° F AIR TEMP.<br>SAE 20 BELOW 10° F AIR TEMP.   |
|   | C                     | MIL-H-5606 HYDRAULIC FLUID, PETROLEUM BASE   |
|   | D                     | MIL-G-23827 GREASE, AIRCRAFT AND INSTRUMENT, GEAR AND ACTUATOR SCREW   |
|   | E                     | MIL-G-3545 GREASE, AIRCRAFT, HIGH TEMPERATURE  |
|   | F                     | ALL PURPOSE SLIP SPRAY DUPONT NO. 6611   |
|   |                       | <p><b>SPECIAL INSTRUCTIONS</b></p> <ol style="list-style-type: none"> <li>AIR FILTER - TO CLEAN FILTER, TAP GENTLY TO REMOVE DIRT PARTICLES. DO NOT BLOW OUT WITH COMPRESSED AIR OR USE SOLVENT. REPLACE FILTER IF PUNCTURED OR DAMAGED. TURBOCHARGED ENGINES - CLEAN FILTER IN SOLVENT AND ALLOW TO DRY. DIP IN SAE 10 OIL AND ALLOW TO DRAIN FOUR HOURS.</li> <li>BEARINGS AND BUSHINGS - CLEAN EXTERIOR WITH A DRY TYPE SOLVENT BEFORE RELUBRICATING.</li> <li>LANDING GEAR AND FLAP TRANSMISSIONS AND SCREWS, TRIM SCREWS AND WHEEL BEARINGS - DISASSEMBLE AND CLEAN WITH A DRY TYPE SOLVENT. WHEN REASSEMBLING TRANSMISSIONS, FILL WITH LUBRICANT AND APPLY A THIN COATING TO SCREW.</li> <li>OILED STRUTS AND BRAKE RESERVOIR - FILL PER INSTRUCTIONS ON UNIT OR CONTAINER, OR REFER TO SERVICE MANUAL, SECTION II.</li> <li>PROPELLER - REMOVE ONE OF THE TWO GREASE FITTINGS FOR EACH BLADE. APPLY GREASE THROUGH FITTING UNTIL FRESH GREASE APPEARS AT HOLE OF REMOVED FITTING.</li> <li>LUBRICATION POINTS - WIPE ALL LUBRICATION POINTS CLEAN OF OLD GREASE, OIL DIRT, ETC., BEFORE RELUBRICATING.</li> <li>LUBRICATING OIL - INTERVALS BETWEEN OIL CHANGES CAN BE INCREASED AS MUCH AS 100% ON ENGINES EQUIPPED WITH FULL FLOW (CARTRIDGE TYPE) OIL FILTERS, PROVIDED THE ELEMENT IS REPLACED EACH 50 HOURS OF OPERATION.</li> <li>LUBRICATE FLAP TRACK WITH DUPONT'S ALL PURPOSE SLIP SPRAY #6611. FLAPS REQUIRE CLEANING AND LUBRICATION AFTER EXPOSURE TO AN ABNORMAL QUANTITY OF WATER. FLAPS WITH NYLON ROLLERS WILL NOT REQUIRE LUBRICATION ON EITHER FLAP TRACKS OR ROLLERS.</li> <li>OVERHEAD TRIM PULLEYS - LUBRICATION MAY BE EXTENDED TO 250 HOURS WHEN DUSTY CONDITIONS ARE AT A MINIMUM.</li> </ol> <p><b>NOTES</b></p> <ol style="list-style-type: none"> <li>WHEEL BEARINGS REQUIRE CLEANING AND REPACKING AFTER EXPOSURE TO AN ABNORMAL QUANTITY OF WATER.</li> <li>SEE LYCOMING SERVICE INSTRUCTIONS NO. 1014 FOR USE OF DETERGENT OIL.</li> </ol> <p><b>CAUTIONS</b></p> <ol style="list-style-type: none"> <li>DO NOT USE HYDRAULIC FLUID WITH A CASTOR OIL OR ESTER BASE.</li> <li>DO NOT OVER-LUBRICATE COCKPIT CONTROLS.</li> <li>DO NOT APPLY LUBRICANT TO RUBBER PARTS.</li> </ol> |